

# Amara Apartments

1927 Talavera Ridge  
San Antonio, TX 78257

## UNIT SPECIFICATIONS

Issue / Date:

Constuction Set 02-21-2017

Past Issues:  
Pricing Set 10-21-2016



PEEL  
PAULSON  
DESIGN  
STUDIO

[ UNIT ]

## AMARA APARTMENTS TABLE OF CONTENTS

---

1. GENERAL FINISH NOTES
2. FLOORING FINISHES
3. BASE & TRIM FINISHES
4. PAINT & WALL FINISHES
5. MILLWORK FINISHES
6. LIGHT FIXTURES
7. PLUMBING FIXTURES
8. BATH ACCESSORIES
9. DOOR STYLE & HARDWARE
10. MISCELLANEOUS



PEEL  
PAULSON  
DESIGN  
STUDIO

## GENERAL FINISH NOTES

---

1. Contractor to provide all specified finish material submittals to Interior Designer for approval prior to ordering. Any suggested alternate finishes to be submitted to Interior Designer for approval.
2. All paint & stain samples to be sampled at jobsite for Interior Designer approval prior to painting full project.
3. Paint quality & application / preparation methods included.
4. Alternates will not be accepted on specified materials without the approval of the Interior Designer.
5. All finish specifications and finish materials must be cross-checked and verified by subcontractors prior to ordering. Any discrepancies require notification to the Interior Designer and the General Contractor prior to installation of materials.
6. "unless noted otherwise" will be abbreviated as "u.n.o." within this specification manual.
7. Coordinate location of pendant light fixtures on site with Interior Designer prior to installation.
8. Refer to manufacturer's recommended installation methods for all finish materials included in this package.
9. Re-use of enclosed specifications and corresponding documents for purposes other than the above referenced project are forbidden without written permission of PPDS.



PEEL  
PAULSON  
DESIGN  
STUDIO

UNIT  
FLOORING FINISHES

**Project Information**



Amara Apartments  
1927 Talavera Ridge  
San Antonio, TX



**Project Designer Information**

Lead Designer:  
Janna Paulson, IIDA, LEED AP  
[janna@ppds-inc.com](mailto:janna@ppds-inc.com)

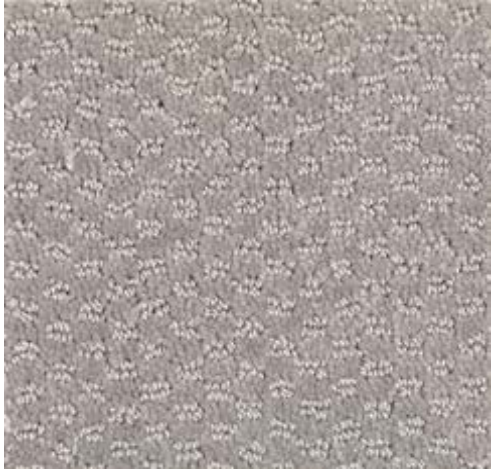

PEEL  
PAULSON  
DESIGN  
STUDIO

<b>FLOOR - CARPET</b>		U-C-1
Location: All Unit Bedrooms and Walk-In Closets  Description: Broadloom Carpet Manufacturer: Mohawk Properties Collection Style: Hounds Run Color: #959 Putty Gray Width: 12' Broadloom Fiber: 100% Bcf P.E.T. Mohawk Everstrand Type: Looped/Cut Pile Pattern Repeat: 3/4"w x 3/4"l Installation: Over 1/2" 5Lbs. Pad		
Notes: **Flooring transition strips between dissimilar floor finish materials must not to exceed max. 1/4"H, if transition strip exceeds 1/4"H, it must not exceed 1/2"H with top 1/4" having a 1:2 or shallower bevel. If Exceeding max 1/2"H it must then have a 1:12 or shallower slope		
<b>Contact Information</b>		
Recommended Vendor: Mohawk Industries Address: 4602 Perrin Creek #1240 San Antonio, TX 78217 Website: <a href="http://www.mohawkflooring.com">www.mohawkflooring.com</a>  Contact: Trey Cerday Phone: (512) 694-5517 Email: <a href="mailto:trey_cerday@mohawkind.com">trey_cerday@mohawkind.com</a>		
<b>Project Information</b>		
Amara Apartments 1927 Talavera Ridge San Antonio, TX		
<b>Project Designer Information</b>		
Lead Designer: Janna Paulson, IIDA, LEED AP <a href="mailto:janna@ppds-inc.com">janna@ppds-inc.com</a>		

FLOOR - VINYL PLANK, PACKAGE 1		U-VP-1
<p>Location: Throughout Package 1 Units EXCEPT Bedrooms and Closets</p> <p>Description: Vinyl Plank                      Manufacturer: FloorFolio                      Collection: Design on Demand                      SKU: 436-10302                      Color: 10302                      Texture: Hand Scraped                      Size: 7.25"x 48"                      Overall Thickness: .080" / 2mm                      Wear Layer: 8 mil / .20mm                      Installation: Direct Glue</p>		
<p>Notes:</p> <p>**Flooring transition strips between dissimilar floor finish materials must not to exceed max. 1/4"H, if transition strip exceeds 1/4"H, it must not exceed 1/2"H with top 1/4" having a 1:2 or shallower bevel. If Exceeding max 1/2"H it must then have a 1:12 or shallower slope</p>		
<p><b>Contact Information</b></p> <p>Recommended Vendor: FloorFolio                      Address: 110 Mayfield Ave.                      Edison, NJ 08837                      Website: <a href="http://www.floorfolio.com">www.floorfolio.com</a></p> <p>Contact: Josh Carter                      Phone: 469.500.0834                      Email: <a href="mailto:jcarter@floorfolio.com">jcarter@floorfolio.com</a></p>		
<p><b>Project Information</b></p> <p>Amara Apartments                      1927 Talavera Ridge                      San Antonio, TX</p>		
<p><b>Project Designer Information</b></p> <p>Lead Designer:                      Janna Paulson, IIDA, LEED AP  <a href="mailto:janna@ppds-inc.com">janna@ppds-inc.com</a></p>		

**FLOOR: VINYL PLANK, PACKAGE 2 & TOWNHOMES** U-VP-2

Location: Throughout Package 2 Units EXCEPT Bedrooms and Closets  
 Throughout Townhomes EXCEPT Bedrooms

Description: Vinyl Plank  
 Manufacturer: FloorFolio  
 Collection: Enviroquiet on Demand  
 SKU: 436-10806-B  
 Color: 10806  
 Texture: Hand Scraped  
 Size: 7.25"x 48"  
 Overall Thickness: .080" / 2mm  
 Wear Layer: 8 mil / .20mm  
 Installation: Direct Glue



Notes:  
 \*\*Flooring transition strips between dissimilar floor finish materials must not to exceed max. 1/4"H, if transition strip exceeds 1/4"H, it must not exceed 1/2"H with top 1/4" having a 1:2 or shallower bevel. If Exceeding max 1/2"H it must then have a 1:12 or shallower slope

**Contact Information**

Recommended Vendor: FloorFolio  
 Address: 110 Mayfield Ave.  
 Edison, NJ 08837  
 Website: [www.floorfolio.com](http://www.floorfolio.com)

Contact: Josh Carter  
 Phone: 469.500.0834  
 Email: [jcarter@floorfolio.com](mailto:jcarter@floorfolio.com)

**Project Information**

Amara Apartments  
 1927 Talavera Ridge  
 San Antonio, TX

**Project Designer Information**

Lead Designer:  
 Janna Paulson, IIDA, LEED AP  
[janna@ppds-inc.com](mailto:janna@ppds-inc.com)



PEEL  
 PAULSON  
 DESIGN  
 STUDIO

UNIT  
BASE & TRIM FINISHES

**Project Information**

Amara  
1927 Talavera Ridge  
San Antonio, TX 78257



**Project Designer Information**

Lead Designer:  
Janna Paulson, IIDA, LEED AP  
[janna@ppds-inc.com](mailto:janna@ppds-inc.com)



PEEL  
PAULSON  
DESIGN  
STUDIO



<b>BASE</b>		U-B-1
Location: All Units throughout  Description: Painted Wood Base Manufacturer: Millwork Subcontractor Profile: Square Edge Size: 1" x 6" Species: FJ Pine Paint: U-PT-2 Sherwin Williams SW 7070 Site White  Finish: Semi gloss		
Notes: **Contractor may provide "or equal" profile for Interior Designer's approval.		
<b>Contact Information</b>		
Recommended Vendor:	Millwork Subcontractor	
Address:		
Website:		
Contact:		
Phone:		
Email:		
<b>Project Information</b>		
Amara 1927 Talavera Ridge San Antonio, TX 78257		
<b>Project Designer Information</b>		
Lead Designer: Janna Paulson, IIDA, LEED AP <a href="mailto:janna@ppds-inc.com">janna@ppds-inc.com</a>		

<b>TRIM: DOOR CASING</b>		U-TM-1
Location: All Units throughout  Description: Door Casing Manufacturer: Millwork Subcontractor Profile: Square Edge Size: 1" x 4" Species: FJ Pine Paint: U-PT-2 Sherwin Williams SW 7070 Site White  Finish: Semi gloss		
Notes: **Contractor may provide "or equal" profile for Interior Designer's approval.		
<b>Contact Information</b> Recommended Vendor: Millwork Subcontractor Address:  Website:  Contact: Phone: Email:		
<b>Project Information</b>  Amara 1927 Talavera Ridge San Antonio, TX 78257		
<b>Project Designer Information</b>  Lead Designer: Janna Paulson, IIDA, LEED AP <a href="mailto:janna@ppds-inc.com">janna@ppds-inc.com</a>		

# TRIM - TILE EDGE PROTECTION

U-TM-2

Location: All Unit Bathrooms throughout  
(Finishing trim for exposed vertical edges of tub and shower wall tile)

Description: Tile Edge Protection

Manufacturer: Schluter

Profile: JOLLY

Style: A100AT

Size: 3/8" - 10mm

Finish: AT Satin Nickel  
Anodize Aluminum

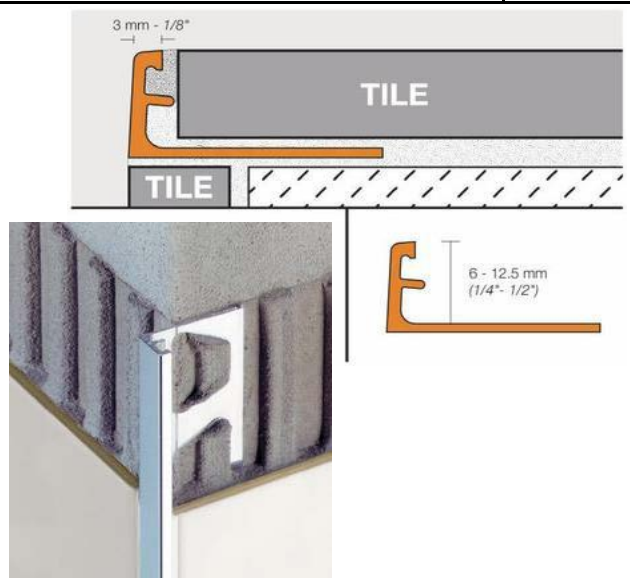

Notes:

- \*\*Contractor may provide "or equal" profile for Interior Designer's approval.
- \*\*To be installed at exposed vertical edges only.

## Contact Information

Recommended Vendor: Interceramic

Address: 9701 Metric Blvd., #100  
Austin, TX 78758

Website: [www.interceramicusa.com](http://www.interceramicusa.com)

Contact: Esther Rollins

Phone: 512-497-9459

Email: [erollins@interceramic.com](mailto:erollins@interceramic.com)

## Project Information

Amara  
1927 Talavera Ridge  
San Antonio, TX 78257

## Project Designer Information

Lead Designer:  
Janna Paulson, IIDA, LEED AP  
[janna@ppds-inc.com](mailto:janna@ppds-inc.com)



UNIT  
PAINT & WALL FINISHES

**Project Information**

Amara  
1927 Talavera Ridge  
San Antonio, TX 78257



**Project Designer Information**

Lead Designer:  
Janna Paulson, IIDA, LEED AP  
[janna@ppds-inc.com](mailto:janna@ppds-inc.com)



PEEL  
PAULSON  
DESIGN  
STUDIO

<b>PAINT</b>		U-PT-1
Location: All Unit Walls and Ceiling Paint Throughout  Description: Unit Wall and Ceiling Paint Manufacturer: Sherwin Williams Color: Silverplate Number: SW 7649 Finish: Flat Finish (Unit walls and ceiling u.n.o.) Semigloss Finish (Bathroom Walls and Ceiling) Wall Texture: Medium Orange Peel		
Notes: **Low VOC Paints. **Minimum of Two Coats of Paint to cover. **Contractor to provide 2' x 2' mock ups in field for approval prior to ordering paint.		
<b>Contact Information</b>		
Recommended Vendor: Sherwin Williams Address:  Contact: Sherwin Williams Phone: 800-4-SHERWIN Website: <a href="http://www.sherwin-williams.com">www.sherwin-williams.com</a>		
<b>Project Information</b>		 PEEL PAULSON DESIGN STUDIO
Amara 1927 Talavera Ridge San Antonio, TX 78257		
<b>Project Designer Information</b>		
Lead Designer: Janna Paulson, IIDA, LEED AP <a href="mailto:janna@ppds-inc.com">janna@ppds-inc.com</a>		

<b>PAINT</b>		U-PT-2
Location: All Unit Base, Door Casing, and Interior Doors  Description: Trim Paint Manufacturer: Sherwin Williams Color: Site White Number: SW 7070 Finish: Semi Gloss		
Notes: **Low VOC Paints. **Minimum of Two Coats of Paint to cover. **Contractor to provide 2' x 2' mock ups in field for approval prior to ordering paint.		
<b>Contact Information</b>		
Recommended Vendor: Sherwin Williams Address:  Contact: Sherwin Williams Phone: 800-4SHERWIN Website: <a href="http://www.sherwinwilliams.com">www.sherwinwilliams.com</a>		
<b>Project Information</b>		
Amara 1927 Talavera Ridge San Antonio, TX 78257		
<b>Project Designer Information</b>		
Lead Designer: Janna Paulson, IIDA, LEED AP <a href="mailto:janna@ppds-inc.com">janna@ppds-inc.com</a>		

WALL TILE		U-WT-1
<p>Location: All Unit Bathrooms (tub/shower surround)</p> <p>Description: Porcelain Wall Tile</p> <p>Manufacturer: American Tile and Stone</p> <p>Style/Number: STRATOS</p> <p>Color: Silver</p> <p>Size: 12" x 24"</p> <p>Thickness: 3/8" / 9.52mm</p> <p>Installation: Brick Lay (1/3rd off set)</p> <p>Grout Color: Custom Building Products #543 Driftwood</p>		
<p>Notes:</p> <p>**Refer to typical tub and shower wall tile pattern elevations on the next page.</p> <p>**Grout joint to be 1/8" maximum.</p> <p>**Seal all grout joints.</p>		
<p><b>Contact Information</b></p> <p>Recommended Vendor: American Tile and Stone</p> <p>Address: 2020 Rutland Dr. Austin, TX 78758</p> <p>Website: <a href="http://www.americantileandstone.com">www.americantileandstone.com</a></p> <p>Contact: Lance Magana</p> <p>Phone: 512-809-6088</p> <p>Email: <a href="mailto:lmagana@americantile.com">lmagana@americantile.com</a></p>		
<p><b>Project Information</b></p> <p>Amara 1927 Talavera Ridge San Antonio, TX 78257</p>		 <p>PEEL PAULSON DESIGN STUDIO</p>
<p><b>Project Designer Information</b></p> <p>Lead Designer: Janna Paulson, IIDA, LEED AP <a href="mailto:janna@ppds-inc.com">janna@ppds-inc.com</a></p>		

# AMARA UNIT WALL TILE PATTERN

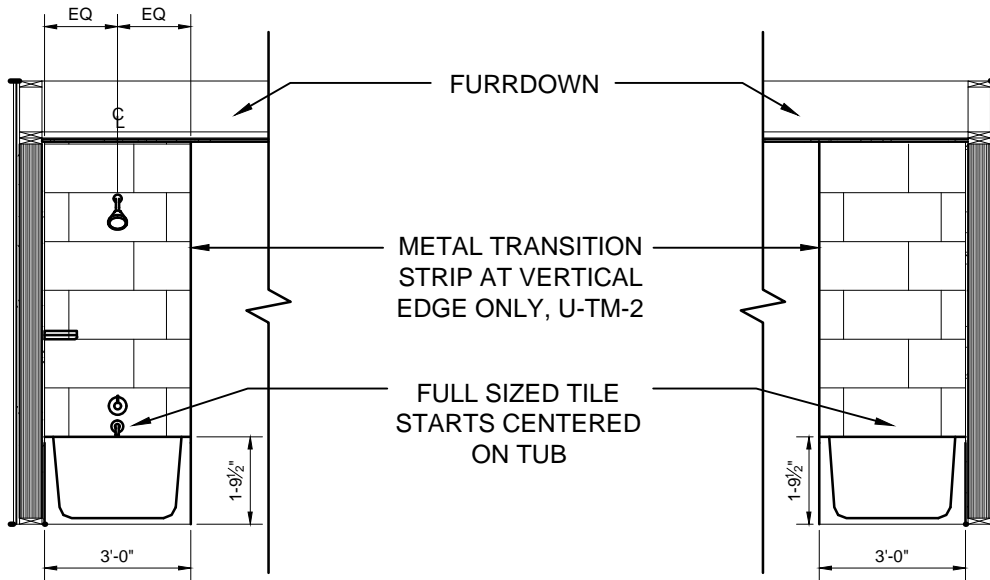

**3** TYP. TUB/SHOWER TILE PATTERN  
SCALE 1/4"=1'-0"

**2** TYP. TUB/SHOWER TILE PATTERN  
SCALE 1/4"=1'-0"

TYPICAL WALL TILE NOTES:

1. AT 7'-10" CEILING HEIGHT - WALL TILE IS TO TERMINATE AT CEILING
2. AT 9'-0" CEILING HEIGHT - WALL TILE IS TO TERMINATE WITH A COMPLETE TILE, APPROX. 8'-2" (+/-).

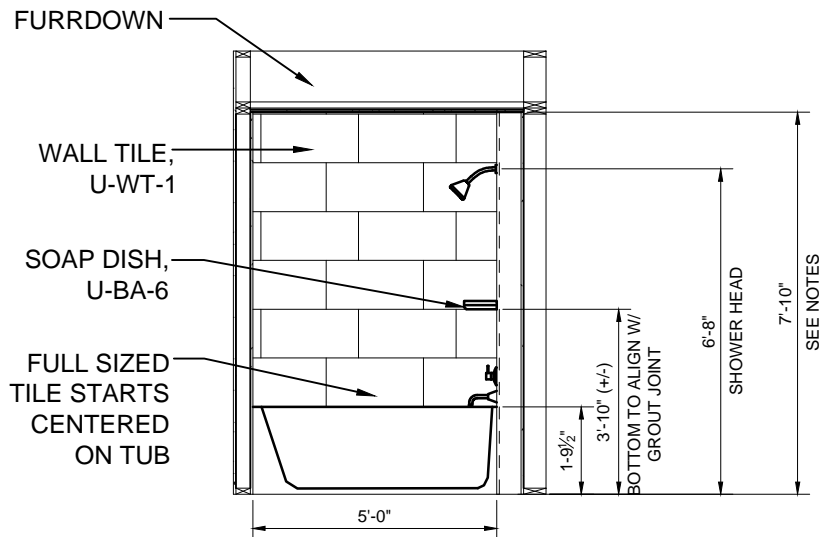

**1** TYP. TUB/SHOWER TILE PATTERN  
SCALE 1/4"=1'-0"



# AMARA UNIT WALL TILE PATTERN

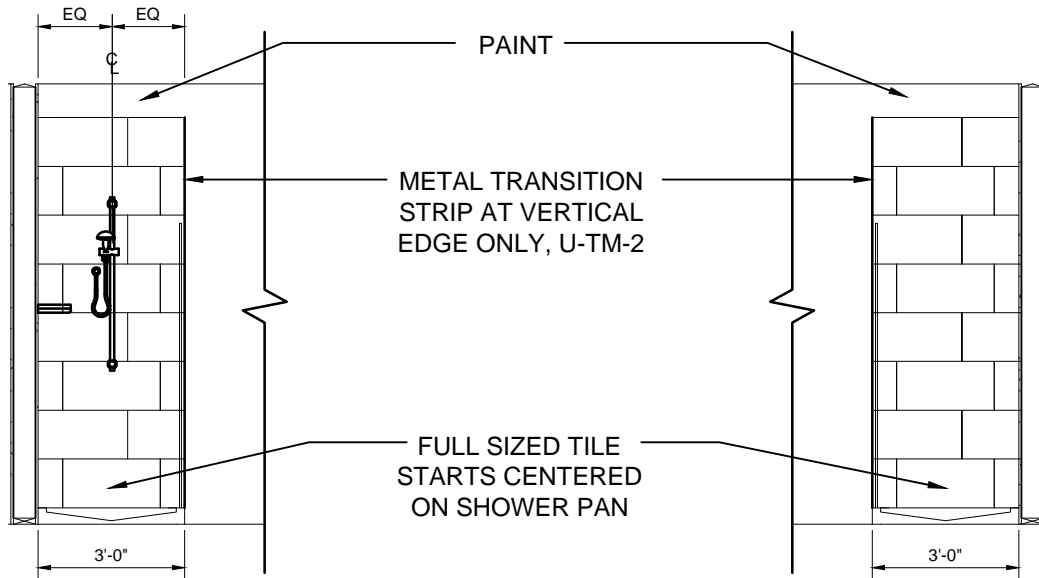

**3** TYP. SHOWER TILE PATTERN  
SCALE 1/4"=1'-0"

**2** TYP. SHOWER TILE PATTERN  
SCALE 1/4"=1'-0"

TYPICAL WALL TILE NOTES:

1. AT 7'-10" CEILING HEIGHT - WALL TILE IS TO TERMINATE AT CEILING
2. AT 9'-0" CEILING HEIGHT - WALL TILE IS TO TERMINATE WITH A COMPLETE TILE, APPROX. 8'-2" (+/-).

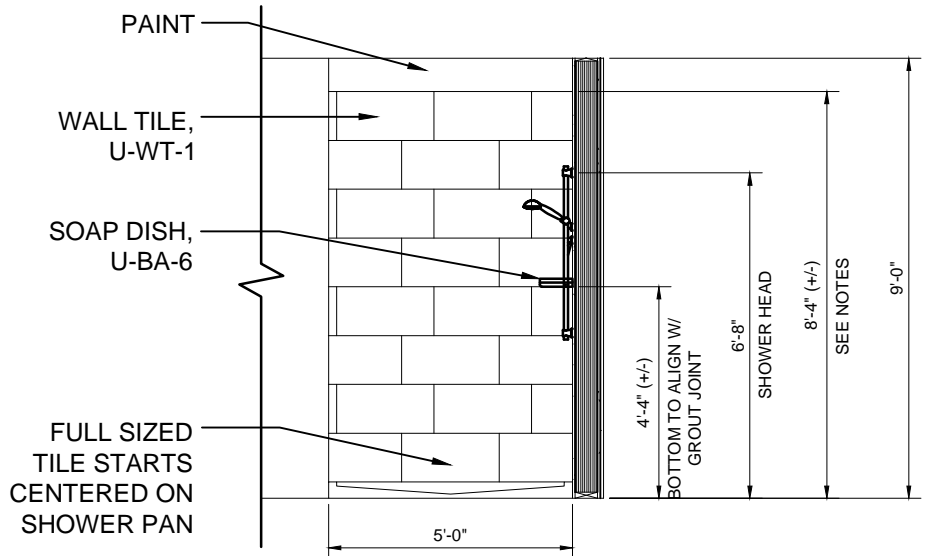

**1** TYP. SHOWER TILE PATTERN  
SCALE 1/4"=1'-0"

# WALL TILE

U-WT-2

Location: All Unit Kitchens  
(Full height Backsplash)

Description: Ceramic Wall Tile

Manufacturer: Interceramic

Style/Number: Burano

Color: Grigio Belfiore

Finish: Matte

Size: 12 " x 13" Victorian Mosaic

Thickness: 3/8"

Installation: See Image

Grout Color: Custom Building Products  
#335 Winter Gray



Notes:  
 \*\*Grout joint to be 1/8" maximum.  
 \*\*Seal all grout joints.

## Contact Information

Recommended Vendor: Interceramic

Address: 9701 Metric Blvd. Ste. 100  
Austin, TX 78758

Website: [www.interceramicusa.com](http://www.interceramicusa.com)

Contact: Esther Rollins

Phone: 512.497.9459

Email: [erollins@interceramic.com](mailto:erollins@interceramic.com)

## Project Information

Amara  
 1927 Talavera Ridge  
 San Antonio, TX 78257

## Project Designer Information

Lead Designer:  
 Janna Paulson, IIDA, LEED AP  
[janna@ppds-inc.com](mailto:janna@ppds-inc.com)



PEEL  
 PAULSON  
 DESIGN  
 STUDIO

# WALL TILE

U-WT-3

Location: Townhome Kitchens  
(Full height Backsplash)

Description: Ceramic Wall Tile

Manufacturer: Interceramic

Style/Number: Burano

Color: Sabbia Mezzo

Finish: Matte

Size: 12 " x 13" Victorian Mosaic

Thickness: 3/8"

Installation: See Image

Grout Color: Custom Building Products  
#11 Snow White



Notes:  
 \*\*Grout joint to be 1/8" maximum.  
 \*\*Seal all grout joints.

## Contact Information

Recommended Vendor: Interceramic

Address: 9701 Metric Blvd. Ste. 100  
Austin, TX 78758

Website: [www.interceramicusa.com](http://www.interceramicusa.com)

Contact: Esther Rollins

Phone: 512.497.9459

Email: [erollins@interceramic.com](mailto:erollins@interceramic.com)

## Project Information

Amara  
 1927 Talavera Ridge  
 San Antonio, TX 78257

## Project Designer Information

Lead Designer:  
 Janna Paulson, IIDA, LEED AP  
[janna@ppds-inc.com](mailto:janna@ppds-inc.com)



PEEL  
 PAULSON  
 DESIGN  
 STUDIO

[ UNIT ]

UNIT  
MILLWORK FINISHES

**Project Information**

Amara  
1927 Talavera Ridge  
San Antonio, TX 78257

**Project Designer Information**

Lead Designer:  
Janna Paulson, IIDA, LEED AP  
[janna@ppds-inc.com](mailto:janna@ppds-inc.com)



PEEL  
PAULSON  
DESIGN  
STUDIO

<b>CABINETRY, PACKAGE 1</b>		U-CAB-1
<p>Location: All Package 1 Unit Kitchen and Bathrooms</p> <p>Description: Manufactured Cabinets Provided by: Master Woodcraft Style: Roma Square Framed, Full Overlay</p> <p>Size: 42" High Upper Cabinets Finish: Nuvolosa Grey</p>		
Notes:		
<b>Contact Information</b>		
<p>Recommended Vendor: Master Woodcraft Address: 232 North Marshall Industrial Avenue Marshall, TX 75670 Website: <a href="http://www.mwccabinetry.com">www.mwccabinetry.com</a></p> <p>Contact: Kelly Adams Phone: (903) 930-5193 Email: <a href="mailto:kadams@mwccabinetry.com">kadams@mwccabinetry.com</a></p>		
<b>Project Information</b>		
<p>Amara 1927 Talavera Ridge San Antonio, TX 78257</p>		
<b>Project Designer Information</b>		
<p>Lead Designer: Janna Paulson, IIDA, LEED AP <a href="mailto:janna@ppds-inc.com">janna@ppds-inc.com</a></p>		

# CABINETRY, PACKAGE 2

U-CAB-2

Location: All Package 2 Unit  
Kitchen and Bathrooms

Description: Manufactured Cabinets  
Provided by: Master Woodcraft  
Style: Roma  
Framed, Full Overlay

Size: 42" High Upper Cabinets  
Finish: Espresso



Notes:

### Contact Information

Recommended Vendor: Master Woodcraft  
Address: 232 North Marshall Industrial Avenue  
Marshall, TX 75670  
Website: [www.mwccabinetry.com](http://www.mwccabinetry.com)

Contact: Kelly Adams  
Phone: (903) 930-5193  
Email: [kadams@mwccabinetry.com](mailto:kadams@mwccabinetry.com)

### Project Information

Amara  
1927 Talavera Ridge  
San Antonio, TX 78257

### Project Designer Information

Lead Designer:  
Janna Paulson, IIDA, LEED AP  
[janna@ppds-inc.com](mailto:janna@ppds-inc.com)



PEEL  
PAULSON  
DESIGN  
STUDIO

# CABINETRY, TOWNHOMES

U-CAB-3

Location: All Townhome Kitchen and Bathrooms

Description: Manufactured Cabinets (Painted)

Provided by: Master Woodcraft

Style: Roma  
Framed, Full Overlay

Size: 42" High Upper Cabinets

Finish: Dover White



Notes:

## Contact Information

Recommended Vendor: Master Woodcraft

Address: 232 North Marshall Industrial Avenue  
Marshall, TX 75670

Website: [www.mwccabinetry.com](http://www.mwccabinetry.com)

Contact: Kelly Adams

Phone: (903) 930-5193

Email: [kadams@mwccabinetry.com](mailto:kadams@mwccabinetry.com)

## Project Information

Amara  
1927 Talavera Ridge  
San Antonio, TX 78257

## Project Designer Information

Lead Designer:  
Janna Paulson, IIDA, LEED AP  
[janna@ppds-inc.com](mailto:janna@ppds-inc.com)



PEEL  
PAULSON  
DESIGN  
STUDIO

COUNTERTOP		U-S-1
<p>Location: All Unit Kitchens and Bathrooms</p> <p>Description: Quartz</p> <p>Manufacturer: Enchanted Granite</p> <p>Color: Maple White</p> <p>Thickness: 2cm</p> <p>Edge Profile: Square</p>		
<p>Notes:</p> <p>**4" Quartz backsplash at Bathrooms</p> <p>** No rounded corners or edges</p>		
<p><b>Contact Information</b></p> <p>Recommended Vendor: Enchanted Granite</p> <p>Address: 2910 Beverly Hill St. Houston, TX 77059</p> <p>Website: <a href="http://www.enchantedgranite.com">www.enchantedgranite.com</a></p> <p>Contact: Andrew Baker</p> <p>Phone: 281-998-1700 - Work 281-702-4682 - Cell</p> <p>Email: <a href="mailto:andrew@enchantedgranite.com">andrew@enchantedgranite.com</a></p>		
<p><b>Project Information</b></p> <p>Amara 1927 Talavera Ridge San Antonio, TX 78257</p>		
<p><b>Project Designer Information</b></p> <p>Lead Designer: Janna Paulson, IIDA, LEED AP <a href="mailto:janna@ppds-inc.com">janna@ppds-inc.com</a></p>		
		 <p>PEEL PAULSON DESIGN STUDIO</p>



<b>COUNTERTOP - TOWNHOMES</b>	U-S-2
-------------------------------	-------

Location: All Townhome Kitchens and Bathrooms

Description: Quartz

Manufacturer: Enchanted Granite

Color: Duro Gris

Thickness: 2cm

Edge Profile: Square



Notes:

\*\*4" Quartz backsplash at Bathrooms

\*\* No rounded corners or edges

**Contact Information**

Recommended Vendor: Enchanted Granite

Address: 2910 Beverly Hill St.  
Houston, TX 77059

Website: [www.enchantedgranite.com](http://www.enchantedgranite.com)

Contact: Andrew Baker

Phone: 281-998-1700 - Work  
281-702-4682 - Cell

Email: [andrew@enchantedgranite.com](mailto:andrew@enchantedgranite.com)

**Project Information**

Amara  
1927 Talavera Ridge  
San Antonio, TX 78257

**Project Designer Information**

Lead Designer:  
Janna Paulson, IIDA, LEED AP  
[janna@ppds-inc.com](mailto:janna@ppds-inc.com)



UNIT  
LIGHTING

**Project Information**



Amara  
1927 Talavera Ridge  
San Antonio, TX 78257



**Project Designer Information**



Lead Designer:  
Janna Paulson, IIDA, LEED AP  
[janna@ppds-inc.com](mailto:janna@ppds-inc.com)

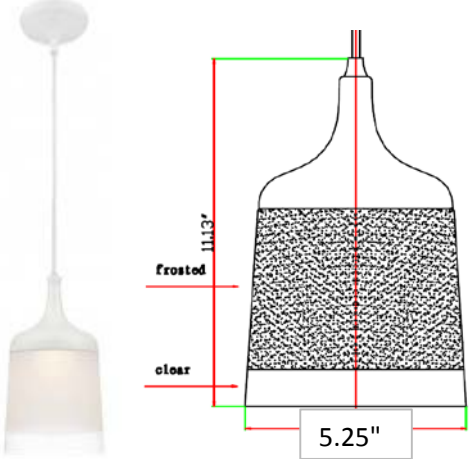

PEEL  
PAULSON  
DESIGN  
STUDIO



LIGHTING		U-DF-1
<p>Location: Unit Bathrooms See Notes</p> <p>Description: Bath Vanity Wall Mount Manufacturer: Sunpark Electronics Style/Number: FL5539D Size: 35.5"L x 4.8"W x 4.5"H Finish: Satin Nickel Lamp: 39W LED, 3000K Installation: Back plate to be 4" above mirror</p>		
<p>Notes:</p> <p>**At single sink vanities, install 1 light fixture, centered on framed mirror, mounted 4" above mirror.</p> <p>**At double sink vanities, install 2 light fixtures, centered above each sink, mounted 4" above framed mirror.</p> <p>**Unit lighting package to be submitted to Interior Designer for final approval.</p> <p>**Contractor to order sample light fixture to confirm approval of fixture</p>		
<p><b>Contact Information</b></p> <p>Recommended Vendor: Sunpark Electronics Address: 16200 S. Figueroa St. Gardena Ca 90248 Website: <a href="http://www.sunparkelectronics.com">www.sunparkelectronics.com</a> Contact: Customer Service Phone: 310-324-8880 Email:</p>		
<p><b>Project Information</b></p> <p>Amara 1927 Talavera Ridge San Antonio, TX 78257</p>		
<p><b>Project Designer Information</b></p> <p>Lead Designer: Janna Paulson, IIDA, LEED AP <a href="mailto:janna@ppds-inc.com">janna@ppds-inc.com</a></p>		



<b>LIGHTING</b>		<b>U-DF-2</b>
<p>Location: Kitchen Bar Pendant</p> <p>Description: Custom Pendant</p> <p>Manufacturer: M &amp; M Lighting</p> <p>Style/Number: 65-556-WH (E21)</p> <p>Size: 5.25" Dia x 11.13"H</p> <p>Finish: Brushed Nickel</p> <p>Lamp: (1) 60W</p> <p>Shade: Frosted and Clear Glass</p>	 <p style="text-align: center;">*FINISH TO BE BRUSHED NICKEL*</p>	
<p>Notes:</p> <p>**Refer to MEP plans for quantities and locations.</p> <p>**Unit lighting package to be submitted to Interior Designer for final approval.</p>		
<b>Contact Information</b>		
<p>Recommended Vendor:</p> <p>Address:</p> <p>Website:</p> <p>Contact:</p> <p>Phone:</p> <p>Email:</p>	<p>M &amp; M Lighting</p> <p>5620 S. Rice Ave.</p> <p>Houston, TX 77081</p> <p><a href="http://www.mmlighting.com">www.mmlighting.com</a></p> <p>Kitty Jennings</p> <p>(512) 971-5529</p> <p><a href="mailto:mmcrj@mmlighting.com">mmcrj@mmlighting.com</a></p>	
<b>Project Information</b>		
<p>Amara</p> <p>1927 Talavera Ridge</p> <p>San Antonio, TX 78257</p>		
<b>Project Designer Information</b>		
<p>Lead Designer:</p> <p>Janna Paulson, IIDA, LEED AP</p> <p><a href="mailto:janna@ppds-inc.com">janna@ppds-inc.com</a></p>		

LIGHTING		U-DF-3		
<p>Location: Entry, Hallway, Kitchen, Dining Areas, Bathrooms</p> <p>Description: Disk Light</p> <p>Manufacturer: Classic Lighting by J&amp;L</p> <p>Style/Number: 120V 6" LED Disk Light LED-SM6D/WT</p> <p>Dimensions: 7.4"D x 1.6"H for 6" can light</p> <p>Finish: White</p> <p>Lamp: (36) 15w LED chips</p>				
<p>Notes:</p> <p>**Refer to MEP plans for location and quantities.</p> <p>**Lighting Sub Contractor to submit equal alternate options for GC pricing.</p> <p>**Unit lighting package to be submitted to Interior Designer for final approval.</p>				
<p><b>Contact Information</b></p>				
<p>Recommended Vendor: J &amp; L Industries Inc.</p> <p>Address: 707 Avenue E. Stafford, TX 77477</p> <p>Website: <a href="http://www.jldistributors.com">www.jldistributors.com</a></p> <p>Contact:</p> <p>Phone: Customer Service</p> <p>Email: 281-403-6733</p>				
<p><b>Project Information</b></p>				
<p>Amara 1927 Talavera Ridge San Antonio, TX 78257</p>				
<p><b>Project Designer Information</b></p>				
<p>Lead Designer: Janna Paulson, IIDA, LEED AP <a href="mailto:janna@ppds-inc.com">janna@ppds-inc.com</a></p>				



<b>LIGHTING</b>		U-DF-4
Location: Unit Exterior Patio Storage  Description: Mushroom Ceiling Mount Manufacturer: Lumivert Incorporated Style/Number: 2 Light Opal Mushroom, Energy Saving #ES2801-2131 WT  Size: 9-1/2"W x 5"H Finish: White Lamp: (2)13W T2 Spiral CFL E26 Base 3000K		
Notes: **Refer to MEP plans for quantities and locations. **Lighting Sub Contractor to submit equal alternate options for GC pricing. **Unit lighting package to be submitted to Interior Designer for final approval.		
<b>Contact Information</b>		
Recommended Vendor: Address:  Website:  Contact: Phone: Email:	Lumivert Lighting, Inc. 1515 Mesquite, #C Houston, TX 77093 <a href="http://www.lumivertlighting.com">www.lumivertlighting.com</a>  Customer Service 281-227-8378	
<b>Project Information</b>		
Amara 1927 Talavera Ridge San Antonio, TX 78257		
<b>Project Designer Information</b>		
Lead Designer: Janna Paulson, IIDA, LEED AP <a href="mailto:janna@ppds-inc.com">janna@ppds-inc.com</a>		

[ UNIT ]

LIGHTING		U-DF-5
Location:	Unit Utility and Closets	
Description:	Mushroom Ceiling Mount	
Manufacturer:	Lumivert Incorporated	
Style/Number:	2 Light Opal Mushroom, Energy Saving #ES2801-2131 BN	
Size:	9-1/2"W x 5"H	
Finish:	Brushed Nickel	
Lamp:	(2)13W T2 Spiral CFL E26 Base 3000K	
Notes: **Refer to MEP plans for quantities and locations. **Lighting Sub Contractor to submit equal alternate options for GC pricing. **Unit lighting package to be submitted to Interior Designer for final approval.		
<b>Contact Information</b>		
Recommended Vendor:	Lumivert Lighting, Inc.	
Address:	1515 Mesquite, #C Houston, TX 77093	
Website:	<a href="http://www.lumivertlighting.com">www.lumivertlighting.com</a>	
Contact:	Customer Service	
Phone:	281-277-8378	
Email:		
<b>Project Information</b>		
Amara 1927 Talavera Ridge San Antonio, TX 78257		 PEEL PAULSON DESIGN STUDIO
<b>Project Designer Information</b>		
Lead Designer: Janna Paulson, IIDA, LEED AP <a href="mailto:janna@ppds-inc.com">janna@ppds-inc.com</a>		

<b>LIGHTING</b>		U-DF-6
Location: Unit Living and Bedrooms  Description: Ceiling Fan with Light Kit Manufacturer: Sunway Homenhancements Model: SUN505 NK5SV Model Number: 7RQT4 Size: 52"W sweep Finish: Silver Lamp: (2) 13W CFL Glass: White		
Notes: **Refer to MEP plans for quantities and locations. **Unit lighting package to be submitted to Interior Designer for final approval. **Contractor to order sample light fixture to confirm approval of fixture		
<b>Contact Information</b>		
Recommended Vendor: Address:  Website:  Contact: Phone: Email:	Sunway Homenhancements 1505-A Kelly Blvd. Carrollton, TX 75006 <a href="http://www.homenhancements.com">www.homenhancements.com</a>  Customer Service (972) 416-6090	
<b>Project Information</b>		
Amara 1927 Talavera Ridge San Antonio, TX 78257	 PEEL PAULSON DESIGN STUDIO	
<b>Project Designer Information</b>		
Lead Designer: Janna Paulson, IIDA, LEED AP <a href="mailto:janna@ppds-inc.com">janna@ppds-inc.com</a>		



<b>LIGHTING</b>		U-DF-7
Location: Unit Balcony  Description: Outdoor Wall Mount, Steel Pan and Aluminum Frame  Manufacturer: Divine Lighting Style/Number: Sundance SUNT Size: 6"W x 9"H x 4"D Finish: DB Dark Bronze, MT-Metal Top Lamp: S13GU - (1) 13WGU24 Color Temp: 4100K Lens: WP-White Polycarbonate Ballast: 120 v class P, 60 Hz. Magnetic		
Notes: **Refer to MEP plans for quantities and locations. **Unit lighting package to be submitted to Interior Designer for final approval.		
<b>Contact Information</b>		
Recommended Vendor: Address:  Website:  Contact: Phone: Email:	Divine Lighting 3704 Hilltop, Ste. 200 Conroe, Texas 77303 <a href="http://www.divinelighting.net">www.divinelighting.net</a>  Customer Service 936-494-3900	
<b>Project Information</b>		
Amara 1927 Talavera Ridge San Antonio, TX 78257		
<b>Project Designer Information</b>		
Lead Designer: Janna Paulson, IIDA, LEED AP <a href="mailto:janna@ppds-inc.com">janna@ppds-inc.com</a>		

UNIT  
PLUMBING FIXTURES

**Project Information**

Amara  
1927 Talavera Ridge  
San Antonio, TX 78257

**Project Designer Information**

Lead Designer:  
Janna Paulson, IIDA, LEED AP  
[janna@ppds-inc.com](mailto:janna@ppds-inc.com)





PEEL  
PAULSON  
DESIGN  
STUDIO



<b>SINK FAUCET</b>		U-PF-1
Location: Unit Kitchen  Description: Single Handle Pull-Down Faucet Manufacturer: Pfister Dimensions: 15 25/32"H x 9 1/32" Projection Style: Pasadena Model Number: F-529-7PDS-SS Finish: Stainless Steel Mounting: Single Hole Installation		
Notes: **Contractor to submit equal alternates for Interior Designer's approval. **ADA Compliant. **Contractor to purchase sample fixture to confirm client approval prior to ordering fuxtures for entire project		
<b>Contact Information</b>		
Recommended Vendor: Pfister Faucets Address: 19701 DaVinci Lake Forest, California 92610  Contact: Customer Service Phone: 1-800-732-8238 Website: <a href="http://www.pfisterfaucets.com">www.pfisterfaucets.com</a>		
<b>Project Information</b>		
Amara 1927 Talavera Ridge San Antonio, TX 78257		
<b>Project Designer Information</b>		
Lead Designer: Janna Paulson, IIDA, LEED AP <a href="mailto:janna@ppds-inc.com">janna@ppds-inc.com</a>		

<b>SINK FAUCET</b>		U-PF-2
Location: Unit Bathroom Faucet  Description: Single Control Centerset Faucet Manufacturer: Delta Style Name: Trinsic High Arc Swivel Spout Model Number: 559-HA-SS-DST Size: 8 7/8"H Finish: Brushed Nickel Mounting: One Hole Installation Features: ADA Compliant, 1.5gpm		
Notes: **Contractor to submit equal alternates for Interior Designer's approval. **Contractor to ensure proper clearance for faucet lever before ordering. **Contractor to purchase sample fixture to confirm client approval prior to ordering fuxtures for entire project		
<b>Contact Information</b>		
Recommended Vendor: Delta Address:  Website: <a href="http://www.deltafaucet.com">www.deltafaucet.com</a>  Contact: Customer Service Phone: Email: <a href="mailto:www.customerservice@deltafaucet.com">www.customerservice@deltafaucet.com</a>		
<b>Project Information</b>		
Amara 1927 Talavera Ridge San Antonio, TX 78257	 PEEL PAULSON DESIGN STUDIO	
<b>Project Designer Information</b>		
Lead Designer: Janna Paulson, IIDA, LEED AP <a href="mailto:janna@ppds-inc.com">janna@ppds-inc.com</a>		

<b>TUB/SHOWER</b>		U-PF-3
Location: All Unit Bathrooms  Description: Single Control tub/shower Trim Manufacturer: CFG by Moen Style Name: Cornerstone Model Number: 4311CBNGR Finish: Brushed Nickel **Note: Use Moen brushed nickel one function 5 7/8" diameter Eco Performance shower head with trim kit. #S6312EPBN  GPM: 1.75 gpm		
Notes: **Contractor to provide all necessary components required for installation. **Contractor to submit equal alternates for Interior Designer's approval. **Contractor to purchase sample fixture to confirm client approval prior to ordering fuxtures for entire project		
<b>Contact Information</b>		
Recommended Vendor: CFG by Moen Address:  Website: <a href="http://www.cfgonline.com">www.cfgonline.com</a>  Contact: Customer Service Phone: 888-450-5522 Email:		
<b>Project Information</b>		
Amara 1927 Talavera Ridge San Antonio, TX 78257		
<b>Project Designer Information</b>		
Lead Designer: Janna Paulson, IIDA, LEED AP <a href="mailto:janna@ppds-inc.com">janna@ppds-inc.com</a>		



<b>SHOWER ONLY</b>		U-PF-4
Location: Unit Bathrooms  Description: Single Control Showerhead and Flange  Manufacturer: CFG by Moen Style Name: Cornerstone Model Number: 40315CBNGR Finish: Brushed Nickel **Note: Use Moen brushed nickel one function 5 7/8" diameter Eco Performance shower head with trim kit. #S6312EPBN  GPM: 1.75 gpm	 	
Notes: **Contractor to provide all necessary components required for installation. **Contractor to submit equal alternates for Interior Designer's approval. **Contractor to purchase sample fixture to confirm client approval prior to ordering fuxtures for entire project		
<b>Contact Information</b> Recommended Vendor: CFG by Moen Address:  Website: <a href="http://www.cfgonline.com">www.cfgonline.com</a>  Contact: Customer Service Phone: 888-450-5522 Email:		
<b>Project Information</b>  Amara 1927 Talavera Ridge San Antonio, TX 78257		
<b>Project Designer Information</b>  Lead Designer: Janna Paulson, IIDA, LEED AP <a href="mailto:janna@ppds-inc.com">janna@ppds-inc.com</a>		

<b>SHOWER - ADA</b>		U-PF-5a
Location: ADA Unit Bathrooms  Description: 3 Function Hand Shower with Bracket Manufacturer: ProFlo Style: PF14310CP Finish: Polished Chrome Features: 1.75 gpm		
Notes: **Contractor to submit equal alternates for Interior Designer's approval. **To be installed in ADA units. **Contractor to purchase sample fixture to confirm client approval prior to ordering fuxtures for entire project		
<b>Contact Information</b>		
Recommended Vendor: ProFlo Address: 10500 Metropolitan Dr Austin, TX 78758 Website: <a href="http://www.proflo.com">www.proflo.com</a> Contact: Customer Service Phone: 512-837-2290 Email:		
<b>Project Information</b>		
Amara 1927 Talavera Ridge San Antonio, TX 78257		
<b>Project Designer Information</b>		
Lead Designer: Janna Paulson, IIDA, LEED AP <a href="mailto:janna@ppds-inc.com">janna@ppds-inc.com</a>		



<b>SHOWER SLIDE BAR - ADA</b>		U-PF-5b
Location: ADA Unit Bathrooms  Description: 24 Slide Bar with 7/8 Brass Bar Manufacturer: ProFlo Style: PF14BSCP Finish: Polished Chrome		
Notes: **Contractor to submit equal alternates for Interior Designer's approval. **To be installed in ADA units. **Contractor to purchase sample fixture to confirm client approval prior to ordering fuxtures for entire project		
<b>Contact Information</b>		
Recommended Vendor: ProFlo Address: 10500 Metropolitan Dr Austin, TX 78758 Website: <a href="http://www.proflo.com">www.proflo.com</a> Contact: Customer Service Phone: 512-837-2290 Email:		
<b>Project Information</b>		
Amara 1927 Talavera Ridge San Antonio, TX 78257		
<b>Project Designer Information</b>		
Lead Designer: Janna Paulson, IIDA, LEED AP <a href="mailto:janna@ppds-inc.com">janna@ppds-inc.com</a>		







[ UNIT ]



SINK		U-PF-6a
Location:	Unit Kitchen	
Manufacturer:	Just Manufacturing	
Description:	Stainless Steel Undermount Single Basin	
Style:	US-1830-A	
Dimensions:	30"L x 18"W	
Bowl Depth:	8"	
Finish:	Stainless Steel	
Gauge:	18	
Drain Punch:	J-35 drain	
Notes:		
**Contractor to purchase sample fixture to confirm client approval prior to ordering fuxtures for entire project		
<b>Contact Information</b>		
Recommended Vendor:	Just Manufacturing	
Address:	9233 King St Franklin Park, IL 60131	
Website:	<a href="http://www.justmfg.com">www.justmfg.com</a>	
Contact:	Customer Service	
Phone:	847-678-5151	
Email:		
<b>Project Information</b>		
Amara 1927 Talavera Ridge San Antonio, TX 78257		 PEEL PAULSON DESIGN STUDIO
<b>Project Designer Information</b>		
Lead Designer: Janna Paulson, IIDA, LEED AP <a href="mailto:janna@ppds-inc.com">janna@ppds-inc.com</a>		

[ UNIT ]



SINK - ADA		U-PF-6b
Location:	ADA Unit Kitchen	
Manufacturer:	Just Manufacturing	
Description:	Stainless Steel Undermount Single Basin	
Style:	US-ADA-1830-A	
Dimensions:	30"L x 18"W	
Bowl Depth:	5 1/2"	
Finish:	Stainless Steel	
Gauge:	18	
<b>Notes:</b> **Plumbing contractor to submit equal alternates. **Sink to be installed per ADA requirements to meet knee clearance dimensions. **Contractor to purchase sample fixture to confirm client approval prior to ordering fuxtures for entire project **To be installed per ADA requirements to meet knee clearance dimensions.		
<b>Contact Information</b>		
Recommended Vendor:	Just Manufacturing	
Address:	9233 King St Franklin Park, IL 60131	
Website:	<a href="http://www.justmfg.com">www.justmfg.com</a>	
Contact:	Customer Service	
Phone:	847-678-5151	
Email:		
<b>Project Information</b>		
Amara 1927 Talavera Ridge San Antonio, TX 78257		 PEEL PAULSON DESIGN STUDIO
<b>Project Designer Information</b>		
Lead Designer: Janna Paulson, IIDA, LEED AP <a href="mailto:janna@ppds-inc.com">janna@ppds-inc.com</a>		

<b>SINK</b>		U-PF-7a
Location: Unit Bathrooms  Description: Undermount Sink Manufacturer: American Standard Style: Ovalyn Undercounter Sink Style Number: 0496.221 Overall Dims: 19.25"W x 16.25"L Bowl Size: 17"W x 14"L x 5.5" Deep Finish: White 020		
Notes: **Plumbing contractor to submit equal alternates. **Contractor to purchase sample fixture to confirm client approval prior to ordering fuxtures for entire project		
<b>Contact Information</b>		
Recommended Vendor: American Standard Address:  Website: <a href="http://www.americanstandard-us.com">www.americanstandard-us.com</a>  Contact: Customer Service Phone: 1-800-442-1902 Email:		
<b>Project Information</b>		
Amara 1927 Talavera Ridge San Antonio, TX 78257		
<b>Project Designer Information</b>		
Lead Designer: Janna Paulson, IIDA, LEED AP <a href="mailto:janna@ppds-inc.com">janna@ppds-inc.com</a>		

<b>SINK- ADA</b>		U-PF-7b
Location: ADA Unit Bathrooms  Description: Undermount Sink Manufacturer: American Standard Style: Ovalyn Undercounter Sink Style Number: 0495.221 Overall Dims: 17-1/8"W x 14-1/8"L Bowl Size: 15-1/16"W x 12-1/16"L x 5.5" Deep Finish: White 020		
Notes: **Plumbing contractor to submit equal alternates. **Sink to be installed per ADA requirements to meet knee clearance dimensions. **Contractor to purchase sample fixture to confirm client approval prior to ordering fuxtures for entire project		
<b>Contact Information</b>		
Recommended Vendor: American Standard Address:  Website: <a href="http://www.americanstandard-us.com">www.americanstandard-us.com</a>  Contact: Customer Service Phone: 1-800-442-1902 Email:		
<b>Project Information</b>		
Amara 1927 Talavera Ridge San Antonio, TX 78257	 PEEL PAULSON DESIGN STUDIO	
<b>Project Designer Information</b>		
Lead Designer: Janna Paulson, IIDA, LEED AP <a href="mailto:janna@ppds-inc.com">janna@ppds-inc.com</a>		

<b>BATH TUB</b>		U-PF-8
Location: All Unit Bathtubs  Description: Bathtub Manufacturer: Spurlin Industries Style: F 6036 GT L/R Finish: White Size: 60"L x 35"W x 21 1/2"H		
Notes: **Contractor to submit equal alternates for Interior Designer's approval. **Contractor to determine left or right drain location based on Architectural drawings. **Contractor to purchase sample fixture to confirm client approval prior to ordering fuxtures for entire project		
<b>Contact Information</b>		
Recommended Vendor: Ferguson Enterprises, Inc Address: 2551 N. Mays Round Rock, TX 78665  Website:  Contact: Scott Supak Phone: 512-751-1580 Email: <a href="mailto:scott.supak@ferguson.com">scott.supak@ferguson.com</a>		
<b>Project Information</b>		 PEEL PAULSON DESIGN STUDIO
Amara 1927 Talavera Ridge San Antonio, TX 78257		
<b>Project Designer Information</b>		
Lead Designer: Janna Paulson, IIDA, LEED AP <a href="mailto:janna@ppds-inc.com">janna@ppds-inc.com</a>		

[ UNIT ]

TOILET		U-PF-9a
Location:	Unit Bathrooms	
Description:	Elongated Toilet	
Manufacturer:	Gerber	
Style Name:	Maxwell HET Elongated Toilet	
Style Number:	21-912	
GPF:	1.28	
Finish:	White	
Notes: **Contractor to submit equal alternates for Interior Designer's approval. **Contractor to purchase sample fixture to confirm client approval prior to ordering fuxtures for entire project		
<b>Contact Information</b>		
Recommended Vendor:	Gerber	
Address:		
Website:	<a href="http://www.gerberonline.com">www.gerberonline.com</a>	
Contact:	Customer Service	
Phone:	866-538-5536	
Email:		
<b>Project Information</b>		
Amara 1927 Talavera Ridge San Antonio, TX 78257		
<b>Project Designer Information</b>		
Lead Designer: Janna Paulson, IIDA, LEED AP <a href="mailto:janna@ppds-inc.com">janna@ppds-inc.com</a>		

<b>TOILET - ADA</b>		U-PF-9b
Location: ADA Unit Bathrooms  Description: Elongated Toilet Manufacturer: Gerber Style Name: Maxwell HET Elongated Toilet Style: 21-918 GPF: 1.28 Finish: White		
Notes: **Contractor to submit equal alternates for Interior Designer's approval. **To be installed in ADA units. **Contractor to purchase sample fixture to confirm client approval prior to ordering fuxtures for entire project		
<b>Contact Information</b>		
Recommended Vendor: Gerber Address:  Website: <a href="http://www.gerberonline.com">www.gerberonline.com</a>  Contact: Customer Service Phone: 866-538-5536 Email:		
<b>Project Information</b>		
Amara 1927 Talavera Ridge San Antonio, TX 78257		
<b>Project Designer Information</b>		
Lead Designer: Janna Paulson, IIDA, LEED AP <a href="mailto:janna@ppds-inc.com">janna@ppds-inc.com</a>		

<b>SHOWER PAN</b>		U-PF-10
Location: Unit Bathrooms  Description: Molded Fiberglass Shower Receptor Manufacturer: TBD Style: TBD Finish: White Size: 36"W x 60"L	<h1>TBD</h1>	
Notes: **Contractor to submit equal alternates for Interior Designer's approval. **Contractor to purchase sample fixture to confirm client approval prior to ordering fuxtures for entire project		
<b>Contact Information</b>		
Recommended Vendor: TBD Address:  Contact: Phone: Website:		
<b>Project Information</b>		 PEEL PAULSON DESIGN STUDIO
Amara 1927 Talavera Ridge San Antonio, TX 78257		
<b>Project Designer Information</b>		
Lead Designer: Janna Paulson, IIDA, LEED AP <a href="mailto:janna@ppds-inc.com">janna@ppds-inc.com</a>		



[ UNIT ]

UNIT  
BATH ACCESSORIES

**Project Information**

Amara  
1927 Talavera Ridge  
San Antonio, TX 78257



**Project Designer Information**



Lead Designer:  
Janna Paulson, IIDA, LEED AP  
[janna@ppds-inc.com](mailto:janna@ppds-inc.com)





PEEL  
PAULSON  
DESIGN  
STUDIO



[ UNIT ]

BATH ACCESSORY		U-BA-1
Location:	Unit Bathrooms	
Description:	24" Towel Bar	
Manufacturer:	Taymor	
Style:	Dixon	
Product:	24" Towel Bar	
Model Number:	04-30624SN	
Size:	24" x 13/16" x 1/4"	
Finish:	Satin Nickel	
Notes: **Contractor to submit equal alternates for Interior Designer's approval.		
<b>Contact Information</b>		
Recommended Vendor:	Taymor	
Address:	1655 Derwent Way Annacis Island, Delta, BC V3M6K8	
Contact:	Customer Service	
Phone:	604-540-9525	
Website:	<a href="http://www.taymor.ca">www.taymor.ca</a>	
<b>Project Information</b>		
Amara 1927 Talavera Ridge San Antonio, TX 78257		 PEEL PAULSON DESIGN STUDIO
<b>Project Designer Information</b>		
Lead Designer: Janna Paulson, IIDA, LEED AP <a href="mailto:janna@ppds-inc.com">janna@ppds-inc.com</a>		

BATH ACCESSORY		U-BA-2
<p>Location: Unit Bathrooms</p> <p>Description: 18" Towel Bar</p> <p>Manufacturer: Taymor</p> <p>Style: Dixon</p> <p>Product: 18" Towel Bar</p> <p>Model Number: 04-30618SN</p> <p>Size: 18" x 13/16" x 1/4"</p> <p>Finish: Satin Nickel</p>		
<p>Notes:</p> <p>**Contractor to submit equal alternates for Interior Designer's approval.</p>		
<p><b>Contact Information</b></p> <p>Recommended Vendor: Taymor</p> <p>Address: 1655 Derwent Way Annacis Island, Delta, BC V3M6K8</p> <p>Contact: Customer Service</p> <p>Phone: 604-540-9525</p> <p>Website: <a href="http://www.taymor.ca">www.taymor.ca</a></p>		
<p><b>Project Information</b></p> <p>Amara 1927 Talavera Ridge San Antonio, TX 78257</p>		
<p><b>Project Designer Information</b></p> <p>Lead Designer: Janna Paulson, IIDA, LEED AP <a href="mailto:janna@ppds-inc.com">janna@ppds-inc.com</a></p>		
		

<b>BATH ACCESSORY</b>		U-BA-3
<p>Location: Unit Bathrooms</p> <p>Description: Tissue Holder</p> <p>Manufacturer: Taymor</p> <p>Style: Dixon</p> <p>Product: Standard Paper Holder</p> <p>Model Number: 04-30608SN</p> <p>Finish: Satin Nickel</p>	 <p style="text-align: center;">**Satin Nickel Finish**</p>	
<p>Notes:</p> <p>**Contractor to submit equal alternates for Interior Designer's approval.</p>		
<b>Contact Information</b>		
<p>Recommended Vendor: Taymor</p> <p>Address: 1655 Derwent Way Annacis Island, Delta, BC V3M6K8</p> <p>Contact: Customer Service</p> <p>Phone: 604-540-9525</p> <p>Website: <a href="http://www.taymor.ca">www.taymor.ca</a></p>		
<b>Project Information</b>		
<p>Amara 1927 Talavera Ridge San Antonio, TX 78257</p>	 <p>PEEL PAULSON DESIGN STUDIO</p>	
<b>Project Designer Information</b>		
<p>Lead Designer: Janna Paulson, IIDA, LEED AP <a href="mailto:janna@ppds-inc.com">janna@ppds-inc.com</a></p>		

[ UNIT ]

BATH ACCESSORY		U-BA-4	
Location:	Unit Bathrooms	 <p><b>**Satin Nickel Finish**</b></p>	
Description:	Towel Ring		
Manufacturer:	Taymor		
Style:	Dixon		
Product:	Towel Ring		
Model Number:	04-30604SN		
Finish:	Satin Nickel		
<b>Notes:</b> **Contractor to submit equal alternates for Interior Designer's approval.			
<b>Contact Information</b>			
Recommended Vendor:	Taymor		
Address:	1655 Derwent Way Annacis Island, Delta, BC V3M6K8		
Contact:	Customer Service		
Phone:	604-540-9525		
Website:	<a href="http://www.taymor.ca">www.taymor.ca</a>		
<b>Project Information</b>			
Amara 1927 Talavera Ridge San Antonio, TX 78257		 <p>PEEL PAULSON DESIGN STUDIO</p>	
<b>Project Designer Information</b>			
Lead Designer: Janna Paulson, IIDA, LEED AP <a href="mailto:janna@ppds-inc.com">janna@ppds-inc.com</a>			

[ UNIT ]

## BATH ACCESSORY

U-BA-5

Location: Unit Bathrooms  
Description: Curved Shower Rod  
Manufacturer: Pamex Inc.  
Style: Crescent Curved 5ft Rod  
Model Number: BSR-552  
Size: 5' L x 1"D  
Finish: Satin Nickel

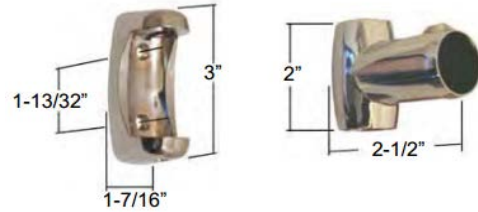

Notes:

### Contact Information

Recommended Vendor: Pamex Inc.  
Address:  
Contact: Customer Service  
Phone: 800-621-6869  
Website: [www.pamexinc.com](http://www.pamexinc.com)

### Project Information

Amara  
1927 Talavera Ridge  
San Antonio, TX 78257

### Project Designer Information

Lead Designer:  
Janna Paulson, IIDA, LEED AP  
[janna@ppds-inc.com](mailto:janna@ppds-inc.com)



PEEL  
PAULSON  
DESIGN  
STUDIO

BATH ACCESSORY		U-BA-6
<p>Location: Unit Bathrooms (At Showers Only)</p> <p>Manufacturer: Intceramics</p> <p>Description: Medium Corner Caddy</p> <p>Style: White Ceramic Bathroom Shelf</p> <p>Finish: Ceramic</p> <p>Size: 8-1/4" x 8-1/4"</p> <p>Color: White</p>		
<p>Notes:</p> <p>**Contractor to submit equal alternates for Interior Designer's approval.</p> <p>**Refer to typical tub/shower wall tile pattern elevation for mounting height. Drawing located in wall tile section of specification book.</p>		
<p><b>Contact Information</b></p>		
<p>Recommended Vendor: Intceramic USA</p> <p>Address: 9701 Metric Blvd., #100 Austin, TX 78758</p> <p>Website: <a href="http://www.interceramicusa.com">www.interceramicusa.com</a></p> <p>Contact: Esther Rollins</p> <p>Phone: 512-497-9459</p> <p>Email: <a href="mailto:erollins@interceramic.com">erollins@interceramic.com</a></p>		
<p><b>Project Information</b></p>		
<p>Amara 1927 Talavera Ridge San Antonio, TX 78257</p>		
<p><b>Project Designer Information</b></p>		
<p>Lead Designer: Janna Paulson, IIDA, LEED AP <a href="mailto:janna@ppds-inc.com">janna@ppds-inc.com</a></p>		

[ UNIT ]

UNIT  
DOOR STYLE & HARDWARE

**Project Information**

Amara  
1927 Talavera Ridge  
San Antonio, TX 78257



**Project Designer Information**

Lead Designer:  
Janna Paulson, IIDA, LEED AP  
[janna@ppds-inc.com](mailto:janna@ppds-inc.com)





PEEL  
PAULSON  
DESIGN  
STUDIO

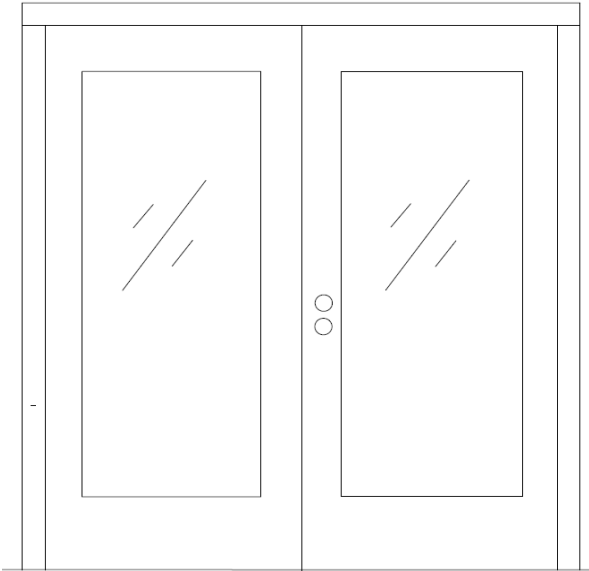

<b>DOOR</b>		U-D-1
<p>Location: All Unit Interior Doors</p> <p>Description: Interior 3 Panel Door</p> <p>Manufacturer: Provided by Sub Contractor</p> <p>Series: 3 Panel</p> <p>Height: 6'-8"</p> <p>Type: Moulded</p> <p>Finish: Smooth</p> <p>Paint Color: U-PT-2 Sherwin Williams SW 7070 Site White</p>		
<p>Notes:</p> <p>**Confirm door height and thickness with Architectural Door Schedule.</p> <p>**Confirm all Fire Rating requirements with Architect.</p>		
<p><b>Contact Information</b></p> <p>Recommended Vendor: Sub Contractor</p> <p>Address:</p> <p>Website:</p> <p>Contact:</p> <p>Phone:</p> <p>Email:</p>		
<p><b>Project Information</b></p> <p>Amara 1927 Talavera Ridge San Antonio, TX 78257</p>		 <p>PEEL PAULSON DESIGN STUDIO</p>
<p><b>Project Designer Information</b></p> <p>Lead Designer: Janna Paulson, IIDA, LEED AP <a href="mailto:janna@ppds-inc.com">janna@ppds-inc.com</a></p>		

<b>DOOR</b>		U-D-2
<p>Location: All Unit Entry Doors</p> <p>Description: Exterior 2 Panel Door</p> <p>Manufacturer: Provided by Sub Contractor</p> <p>Style: 2 Panel, No Glass</p> <p>Height: 8'-0"</p> <p>Type: Metal</p> <p>Finish: Smooth</p> <p>Paint Color: To Be Determined By Owner</p>		
<p>Notes:</p> <p>**Confirm door height and thickness with Architectural Door Schedule.</p> <p>**Confirm all Fire Rating requirements with Architect.</p>		
<p><b>Contact Information</b></p> <p>Recommended Vendor: Sub Contractor</p> <p>Address:</p> <p>Website:</p> <p>Contact:</p> <p>Phone:</p> <p>Email:</p>		
<p><b>Project Information</b></p> <p>Amara 1927 Talavera Ridge San Antonio, TX 78257</p>		 <p>PEEL PAULSON DESIGN STUDIO</p>
<p><b>Project Designer Information</b></p> <p>Lead Designer: Janna Paulson, IIDA, LEED AP <a href="mailto:janna@ppds-inc.com">janna@ppds-inc.com</a></p>		

<b>DOOR</b>		U-D-3
Location: All Unit Patio Doors  Description: Exterior Single Lite Manufacturer: Provided by Sub Contractor Style: Full Lite Metal Door Height: 8'-0" Type: Metal Finish: Smooth Paint Color: To Be Determined By Owner		
Notes: **Confirm door height and thickness with Architectural Door Schedule. **Confirm all Fire Rating requirements with Architect.		
<b>Contact Information</b> Recommended Vendor: Sub Contractor Address:  Contact: Phone: Website:		
<b>Project Information</b>  Amara 1927 Talavera Ridge San Antonio, TX 78257		 PEEL PAULSON DESIGN STUDIO
<b>Project Designer Information</b>  Lead Designer: Janna Paulson, IIDA, LEED AP <a href="mailto:janna@ppds-inc.com">janna@ppds-inc.com</a>		

<b>HARDWARE</b>		U-H-1
Location: Unit Privacy Doors: Bedrooms & Bathrooms  Description: Privacy Door Lever Manufacturer: Better Home Products Style: Soma Lever, Privacy Finish: Satin Nickel		
Notes: **Contractor to verify all locking information with Owner.		
<b>Contact Information</b>		
Recommended Vendor: Better Home Products Address:  Website: <a href="http://www.betterhomeproducts.com">www.betterhomeproducts.com</a>  Contact: Customer Service Phone: 650-827-9270 Email:		
<b>Project Information</b>		
Amara 1927 Talavera Ridge San Antonio, TX 78257		
<b>Project Designer Information</b>		
Lead Designer: Janna Paulson, IIDA, LEED AP <a href="mailto:janna@ppds-inc.com">janna@ppds-inc.com</a>		

HARDWARE		U-H-2
<p>Location: Unit Passage Doors: Entry, Closets &amp; Utility</p> <p>Description: Passage Door Lever</p> <p>Manufacturer: Better Home Products</p> <p>Style: Soma Lever, Passage Door</p> <p>Finish: Satin Nickel</p>		
<p>Notes:</p> <p>**Entry Door to receive Client approved deadbolt provided by Contractor.</p>		
<p><b>Contact Information</b></p> <p>Recommended Vendor: Better Home Products</p> <p>Address:</p> <p>Website: <a href="http://www.betterhomeproducts.com">www.betterhomeproducts.com</a></p> <p>Contact: Customer Service</p> <p>Phone: 650-827-9270</p> <p>Email:</p>		
<p><b>Project Information</b></p> <p>Amara 1927 Talavera Ridge San Antonio, TX 78257</p>		 <p>PEEL PAULSON DESIGN STUDIO</p>
<p><b>Project Designer Information</b></p> <p>Lead Designer: Janna Paulson, IIDA, LEED AP <a href="mailto:janna@ppds-inc.com">janna@ppds-inc.com</a></p>		

HARDWARE		U-H-3
<p>Location: Unit Kitchen &amp; Bathrooms</p> <p>Description: Cabinet Pull</p> <p>Manufacturer: Deltana</p> <p>Style: Bar Pull</p> <p>Model Number: BP3000SS</p> <p>Finish: Stainless Steel</p> <p>Dimensions: 5.25" Overall Length 3" C to C</p>	<p>BP3000SS</p> <p>5 1/4"</p> <p>12 mm</p> <p>3"</p>	
<p>Notes:</p> <p>**Contractor may provide "or equal" for Interior Designer's approval.</p>		
<p><b>Contact Information</b></p> <p>Recommended Vendor: Deltana</p> <p>Address:</p> <p>Website: <a href="http://www.deltana.net">www.deltana.net</a></p> <p>Contact: Customer Service</p> <p>Phone: 1-800-665-2226</p> <p>Email:</p>		
<p><b>Project Information</b></p> <p>Amara 1927 Talavera Ridge San Antonio, TX 78257</p>		
<p><b>Project Designer Information</b></p> <p>Lead Designer: Janna Paulson, IIDA, LEED AP <a href="mailto:janna@ppds-inc.com">janna@ppds-inc.com</a></p>		
		<p>PEEL PAULSON DESIGN STUDIO</p>

UNIT  
MISCELLANEOUS

**Project Information**

Amara  
1927 Talavera Ridge  
San Antonio, TX 78257



**Project Designer Information**

Lead Designer:  
Janna Paulson, IIDA, LEED AP  
[janna@ppds-inc.com](mailto:janna@ppds-inc.com)





PEEL  
PAULSON  
DESIGN  
STUDIO



[ UNIT ]

MISCELLANEOUS		U-M-1	
Location:	All Units throughout		
Description:	Switchplates and Outlet Covers		
Manufacturer:	Cooper Wiring Devices		
Style:	2132W		
Finish:	White		
Notes:			
<b>Contact Information</b>			
Recommended Vendor:	Cooper Wiring Devices		
Address:			
Contact:	Customer Service		
Phone:	866-853-4293		
Website:	<a href="http://www.cooperindustries.com">www.cooperindustries.com</a>		
<b>Project Information</b>			
Amara 1927 Talavera Ridge San Antonio, TX 78257			
<b>Project Designer Information</b>			
Lead Designer: Janna Paulson, IIDA, LEED AP <a href="mailto:janna@ppds-inc.com">janna@ppds-inc.com</a>			



[ UNIT ]

MISCELLANEOUS		U-M-2		
Location: All Units throughout				
Description: Light Switch				
Manufacturer: Cooper Wiring Devices				
Style: Rocker Switch				
Finish: White				
Notes:				
<b>Contact Information</b>				
Recommended Vendor: Cooper Wiring Devices				
Address:				
Contact: Customer Service				
Phone: 866-853-4293				
Website: <a href="http://www.cooperindustries.com">www.cooperindustries.com</a>				
<b>Project Information</b>				
Amara 1927 Talavera Ridge San Antonio, TX 78257	 PEEL PAULSON DESIGN STUDIO			
<b>Project Designer Information</b>				
Lead Designer: Janna Paulson, IIDA, LEED AP <a href="mailto:janna@ppds-inc.com">janna@ppds-inc.com</a>				

MISCELLANEOUS		U-M-3
Location:	All Units throughout	
Description:	Wall Texture	
Manufacturer:	Contractor	
Style:	Medium Orange Peel	
Notes:		
<b>Contact Information</b>		
Recommended Vendor:	General Contractor	
Address:		
Contact:		
Phone:		
Email:		
<b>Project Information</b>		
Amara 1927 Talavera Ridge San Antonio, TX 78257		
<b>Project Designer Information</b>		
Lead Designer: Janna Paulson, IIDA, LEED AP <a href="mailto:janna@ppds-inc.com">janna@ppds-inc.com</a>		

<b>MISCELLANEOUS</b>		U-M-4
Location: Window Blinds Throughout  Description: Faux wood collection Manufacturer: Graber Style: 2" Faux Wood Traditions #2539 Finish: Artic White		
Notes: **Contractor to submit "or equal" options to Interior Designer for approval.		
<b>Contact Information</b>		
Recommended Vendor: Graber Address:  Contact: Customer Service Phone: 877-792-0002 Website: <a href="http://www.graberblinds.com">www.graberblinds.com</a>		
<b>Project Information</b>		
Amara 1927 Talavera Ridge San Antonio, TX 78257		
<b>Project Designer Information</b>		
Lead Designer: Janna Paulson, IIDA, LEED AP <a href="mailto:janna@ppds-inc.com">janna@ppds-inc.com</a>		

<b>MISCELLANEOUS</b>		U-M-5
Location: Unit Bathrooms Throughout  Description: Framed Mirrors Manufacturer: Framerica Style: BW241-061 Finish: Espresso Walnut Size: 2"W x 3/4"H x 1/2"Rabbet		
Notes: **At ADA Units, wood frame to sit directly on vanity backsplash per ADA requirements so that the reflective surface of mirror is at 40" AFF MAX. **At Standard Units, wood frame to be mounted 1.5" above vanity backsplash.		
<b>Contact Information</b>		
Recommended Vendor: Framerica Address: 2 Todd Court Yaphank, NY 11980  Contact: Customer Service Phone: 800-372-6422 Website: <a href="http://www.framerica.com">www.framerica.com</a>		
<b>Project Information</b>		
Amara 1927 Talavera Ridge San Antonio, TX 78257		
<b>Project Designer Information</b>		
Lead Designer: Janna Paulson, IIDA, LEED AP <a href="mailto:janna@ppds-inc.com">janna@ppds-inc.com</a>		