

**Amara
APARTMENTS**

**1927 Talavera Ridge
San Antonio, TX 78257**

**UNIT
SPECIFICATIONS**

10-21-2016 Pricing Set (Not For Construction)



PEEL
PAULSON
DESIGN
STUDIO

[UNIT]

AMARA APARTMENTS TABLE OF CONTENTS

1. GENERAL FINISH NOTES
2. FLOORING FINISHES
3. BASE & TRIM FINISHES
4. PAINT & WALL FINISHES
5. MILLWORK FINISHES
6. LIGHT FIXTURES
7. PLUMBING FIXTURES
8. BATH ACCESSORIES
9. DOOR STYLE & HARDWARE
10. MISCELLANEOUS



PEEL
PAULSON
DESIGN
STUDIO

GENERAL FINISH NOTES

1. Contractor to provide all specified finish material submittals to Interior Designer for approval prior to ordering. Any suggested alternate finishes to be submitted to Interior Designer for approval.
2. All paint & stain samples to be sampled at jobsite for Interior Designer approval prior to painting full project.
3. Paint quality & application / preparation methods included.
4. Alternates will not be accepted on specified materials without the approval of the Interior Designer.
5. All finish specifications and finish materials must be cross-checked and verified by subcontractors prior to ordering. Any discrepancies require notification to the Interior Designer and the General Contractor prior to installation of materials.
6. "unless noted otherwise" will be abbreviated as "u.n.o." within this specification manual.
7. Coordinate location of pendant light fixtures on site with Interior Designer prior to installation.
8. Refer to manufacturer's recommended installation methods for all finish materials included in this package.
9. Re-use of enclosed specifications and corresponding documents for purposes other than the above referenced project are forbidden without written permission of PPDS.



PEEL
PAULSON
DESIGN
STUDIO

UNIT
FLOORING FINISHES



Project Information



Amara Apartments
1927 Talavera Ridge
San Antonio, TX

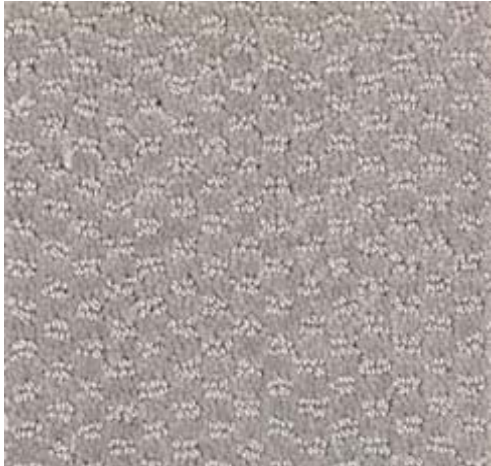

Project Designer Information

Lead Designer:
Janna Paulson, IIDA, LEED AP
janna@ppds-inc.com



FLOOR - CARPET		U-C-1
<p>Location: All Unit Bedrooms and Walk-In Closets</p> <p>Description: Broadloom Carpet</p> <p>Manufacturer: Mohawk Properties Collection</p> <p>Style: Hounds Run</p> <p>Color: #959 Putty Gray</p> <p>Width: 12' Broadloom</p> <p>Fiber: 100% Bcf P.E.T. Mohawk Everstrand</p> <p>Type: Looped/Cut Pile</p> <p>Pattern Repeat: 3/4"w x 3/4"l</p> <p>Installation: Over 1/2" 5Lbs. Pad</p>		
<p>Notes:</p> <p>**Flooring transition strips between dissimilar floor finish materials must not to exceed max. 1/4"H, if transition strip exceeds 1/4"H, it must not exceed 1/2"H with top 1/4" having a 1:2 or shallower bevel. If Exceeding max 1/2"H it must then have a 1:12 or shallower slope</p>		
<p>Contact Information</p> <p>Recommended Vendor: Mohawk Industries</p> <p>Address: 4602 Perrin Creek #1240 San Antonio, TX 78217</p> <p>Website: www.mohawkflooring.com</p> <p>Contact: Trey Cerday</p> <p>Phone: (512) 694-5517</p> <p>Email: trey_cerday@mohawkind.com</p>		
<p>Project Information</p> <p>Amara Apartments 1927 Talavera Ridge San Antonio, TX</p>		
<p>Project Designer Information</p> <p>Lead Designer: Janna Paulson, IIDA, LEED AP janna@ppds-inc.com</p>		
		

FLOOR - VINYL PLANK, PACKAGE 1		U-VP-1
<p>Location: Throughout package 1 unit Bedrooms and Closets</p> <p>Description: Vinyl Plank Manufacturer: FloorFolio Collection: Design on Demand SKU: 436-10302 Color: 10302 Texture: Hand Scraped Size: 7.25"x 48" Overall Thickness: .080" / 2mm Wear Layer: 8 mil / .20mm Installation: Direct Glue</p>		
<p>Notes: **Flooring transition strips between dissimilar floor finish materials must not to exceed max. 1/4"H, if transition strip exceeds 1/4"H, it must not exceed 1/2"H with top 1/4" having a 1:2 or shallower bevel. If Exceeding max 1/2"H it must then have a 1:12 or shallower slope</p>		
<p>Contact Information</p> <p>Recommended Vendor: FloorFolio Address: 110 Mayfield Ave. Edison, NJ 08837 Website: www.floorfolio.com Contact: Josh Carter Phone: 469.500.0834 Email: jcarter@floorfolio.com</p>		
<p>Project Information</p> <p>Amara Apartments 1927 Talavera Ridge San Antonio, TX</p>		
<p>Project Designer Information</p> <p>Lead Designer: Janna Paulson, IIDA, LEED AP janna@ppds-inc.com</p>		

FLOOR: VINYL PLANK, PACKAGE 2 & TOWNHOMES		U-VP-2
<p>Location: Throughout package 2 unit Bedrooms and Closets</p> <p>Throughout townhomes except Bedrooms</p> <p>Description: Vinyl Plank Manufacturer: FloorFolio Collection: Enviroquiet on Demand SKU: 436-10806-B Color: 10806 Texture: Hand Scraped Size: 7.25"x 48" Overall Thickness: .080" / 2mm Wear Layer: 8 mil / .20mm Installation: Direct Glue</p>		
<p>Notes:</p> <p>**Flooring transition strips between dissimilar floor finish materials must not to exceed max. 1/4"H, if transition strip exceeds 1/4"H, it must not exceed 1/2"H with top 1/4" having a 1:2 or shallower bevel. If Exceeding max 1/2"H it must then have a 1:12 or shallower slope</p>		
<p>Contact Information</p> <p>Recommended Vendor: FloorFolio Address: 110 Mayfield Ave. Edison, NJ 08837 Website: www.floorfolio.com</p> <p>Contact: Josh Carter Phone: 469.500.0834 Email: jcarter@floorfolio.com</p>		
<p>Project Information</p> <p>Amara Apartments 1927 Talavera Ridge San Antonio, TX</p>		
<p>Project Designer Information</p> <p>Lead Designer: Janna Paulson, IIDA, LEED AP janna@ppds-inc.com</p>		

UNIT
BASE & TRIM FINISHES



Project Information



Amara
1927 Talavera Ridge
San Antonio, TX 78257

Project Designer Information

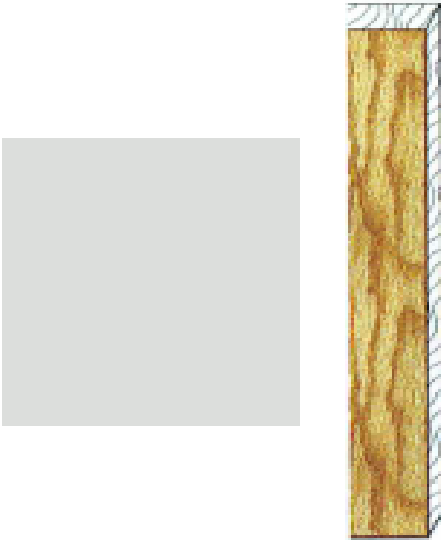
Lead Designer:
Janna Paulson, IIDA, LEED AP
janna@ppds-inc.com



BASE		U-B-1
Location: All Units throughout Description: Painted Wood Base Manufacturer: Millwork Subcontractor Profile: Square Edge Size: 1" x 4" Species: FJ Pine Paint: U-PT-2 Sherwin Williams SW 7070 Site White Finish: Semi gloss		
Notes: **Contractor may provide "or equal" profile for Interior Designer's approval.		
Contact Information		
Recommended Vendor: Millwork Subcontractor Address: Website: Contact: Phone: Email:		
Project Information		
Amara 1927 Talavera Ridge San Antonio, TX 78257		
Project Designer Information		
Lead Designer: Janna Paulson, IIDA, LEED AP janna@ppds-inc.com		

TRIM: DOOR CASING		U-TM-1
Location: All Units throughout Description: Door Casing Manufacturer: Millwork Subcontractor Profile: Square Edge Size: 1" x 4" Species: FJ Pine Paint: U-PT-2 Sherwin Williams SW 7070 Site White Finish: Semi gloss		
Notes: **Contractor may provide "or equal" profile for Interior Designer's approval.		
Contact Information Recommended Vendor: Millwork Subcontractor Address: Website: Contact: Phone: Email:		
Project Information Amara 1927 Talavera Ridge San Antonio, TX 78257		
Project Designer Information Lead Designer: Janna Paulson, IIDA, LEED AP janna@ppds-inc.com		

TRIM - TILE EDGE PROTECTION	U-TM-2
------------------------------------	--------

Location: All Unit Bathrooms throughout
(Finishing trim for exposed vertical edges of tub and shower wall tile)

Description: Tile Edge Protection

Manufacturer: Schluter

Profile: JOLLY

Style: A100AT

Size: 3/8" - 10mm

Finish: AT Satin Nickel
Anodize Aluminum

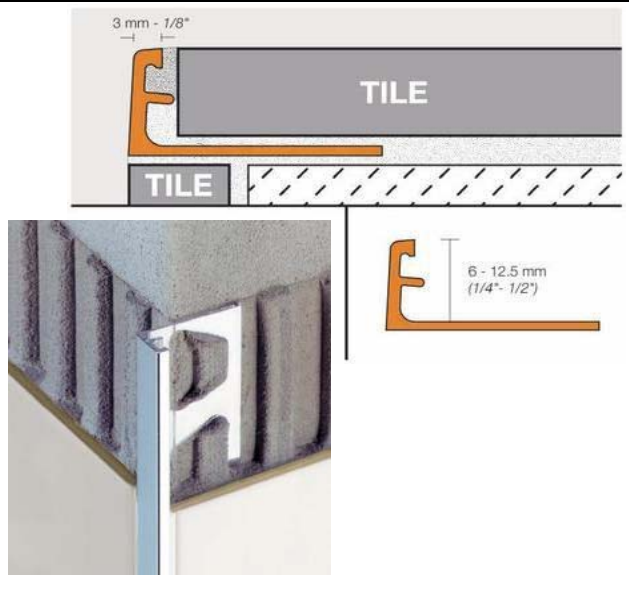

Notes:

**Contractor may provide "or equal" profile for Interior Designer's approval.

**To be installed at exposed vertical edges only.

Contact Information

Recommended Vendor: Interceramic

Address: 9701 Metric Blvd., #100
Austin, TX 78758

Website: www.interceramicusa.com

Contact: Esther Rollins

Phone: 512-497-9459

Email: erollins@interceramic.com

Project Information

Amara
1927 Talavera Ridge
San Antonio, TX 78257

Project Designer Information

Lead Designer:
Janna Paulson, IIDA, LEED AP
janna@ppds-inc.com



[UNIT]

UNIT
PAINT & WALL FINISHES

Project Information



Amara
1927 Talavera Ridge
San Antonio, TX 78257

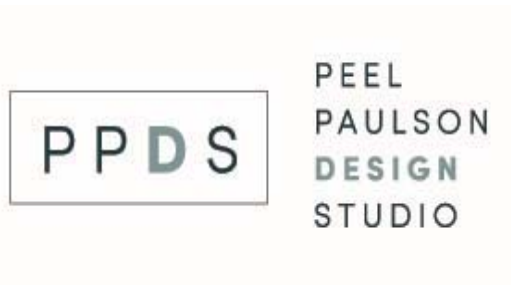

Project Designer Information

Lead Designer:
Janna Paulson, IIDA, LEED AP
janna@ppds-inc.com



PAINT		U-PT-1
Location: All Unit Walls and Ceiling Paint Throughout Description: Unit Wall and Ceiling Paint Manufacturer: Sherwin Williams Color: Silverplate Number: SW 7649 Finish: Flat Finish (Unit walls and ceiling u.n.o.) Semigloss Finish (Bathroom Walls and Ceiling) Wall Texture: Medium Orange Peel		
Notes: **Low VOC Paints. **Minimum of Two Coats of Paint to cover. **Contractor to provide 2' x 2' mock ups in field for approval prior to ordering paint.		
Contact Information		
Recommended Vendor: Sherwin Williams Address: Contact: Sherwin Williams Phone: 800-4-SHERWIN Website: www.sherwin-williams.com		
Project Information		
Amara 1927 Talavera Ridge San Antonio, TX 78257		
Project Designer Information		
Lead Designer: Janna Paulson, IIDA, LEED AP janna@ppds-inc.com		

PAINT		U-PT-2
Location: All Unit Base, Door Casing, and Interior Doors Description: Trim Paint Manufacturer: Sherwin Williams Color: Site White Number: SW 7070 Finish: Semi Gloss		
Notes: **Low VOC Paints. **Minimum of Two Coats of Paint to cover. **Contractor to provide 2' x 2' mock ups in field for approval prior to ordering paint.		
Contact Information		
Recommended Vendor: Sherwin Williams Address: Contact: Sherwin Williams Phone: 800-4SHERWIN Website: www.sherwinwilliams.com		
Project Information		
Amara 1927 Talavera Ridge San Antonio, TX 78257		
Project Designer Information		
Lead Designer: Janna Paulson, IIDA, LEED AP janna@ppds-inc.com		

WALL TILE		U-WT-1
Location: All Unit Bathrooms (tub/shower surround) Description: Porcelain Wall Tile Manufacturer: American Tile and Stone Style/Number: STRATOS Color: Silver Size: 12" x 24" Thickness: 3/8" / 9.52mm Installation: Brick Lay (1/3rd off set) Grout Color: Custom Building Products #543 Driftwood		
Notes: **Refer to typical tub and shower wall tile pattern elevations on the next page. **Grout joint to be 1/8" maximum. **Seal all grout joints.		
Contact Information Recommended Vendor: American Tile and Stone Address: 2020 Rutland Dr. Austin, TX 78758 Website: www.americantileandstone.com Contact: Lance Magana Phone: 512-809-6088 Email: lmagana@americantile.com		
Project Information Amara 1927 Talavera Ridge San Antonio, TX 78257		
Project Designer Information Lead Designer: Janna Paulson, IIDA, LEED AP janna@ppds-inc.com		

WALL TILE

U-WT-2

Location: All Unit Kitchen
(Full height Backsplash)

Description: Ceramic Wall Tile

Manufacturer: Interceramic

Style/Number: Burano

Color: Grigio Belfiore

Finish: Matte

Size: 12 " x 13" Victorian Mosaic

Thickness: 3/8"

Installation: See Image

Grout Color: Custom Building Products
#335 Winter Gray



Notes:

**Grout joint to be 1/8" maximum.

**Seal all grout joints.

Contact Information

Recommended Vendor: Interceramic

Address: 9701 Metric Blvd. Ste. 100
Austin, TX 78758

Website: www.interceramicusa.com

Contact: Esther Rollins

Phone: 512.497.9459

Email: erollins@interceramic.com

Project Information

Amara
1927 Talavera Ridge
San Antonio, TX 78257

Project Designer Information

Lead Designer:
Janna Paulson, IIDA, LEED AP
janna@ppds-inc.com



WALL TILE

U-WT-3

Location: Townhome Kitchens
(Full height Backsplash)

Description: Ceramic Wall Tile

Manufacturer: Interceramic

Style/Number: Burano

Color: Sabbia Mezzo

Finish: Matte

Size: 12 " x 13" Victorian Mosaic

Thickness: 3/8"

Installation: See Image

Grout Color: Custom Building Products
#11 Snow White



Notes:
 **Grout joint to be 1/8" maximum.
 **Seal all grout joints.

Contact Information

Recommended Vendor: Interceramic

Address: 9701 Metric Blvd. Ste. 100
Austin, TX 78758

Website: www.interceramicusa.com

Contact: Esther Rollins

Phone: 512.497.9459

Email: erollins@interceramic.com

Project Information

Amara
 1927 Talavera Ridge
 San Antonio, TX 78257

Project Designer Information

Lead Designer:
 Janna Paulson, IIDA, LEED AP
janna@ppds-inc.com



AMARA UNIT WALL TILE PATTERN

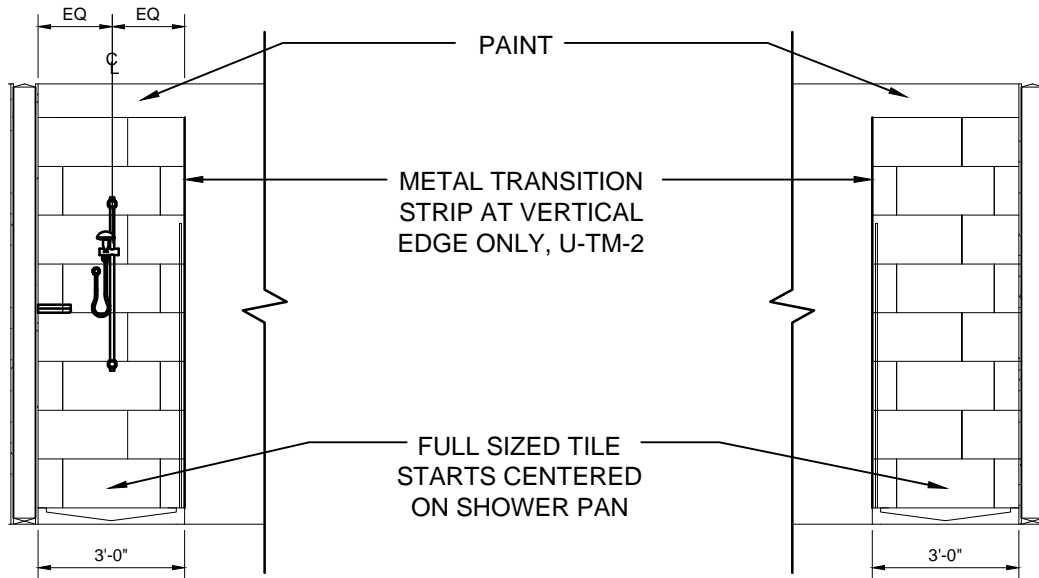

3 TYP. SHOWER TILE PATTERN
SCALE 1/4"=1'-0"

2 TYP. SHOWER TILE PATTERN
SCALE 1/4"=1'-0"

TYPICAL WALL TILE NOTES:

1. AT 7'-10" CEILING HEIGHT - WALL TILE IS TO TERMINATE AT CEILING
2. AT 9'-0" CEILING HEIGHT - WALL TILE IS TO TERMINATE WITH A COMPLETE TILE, APPROX. 8'-2" (+/-).

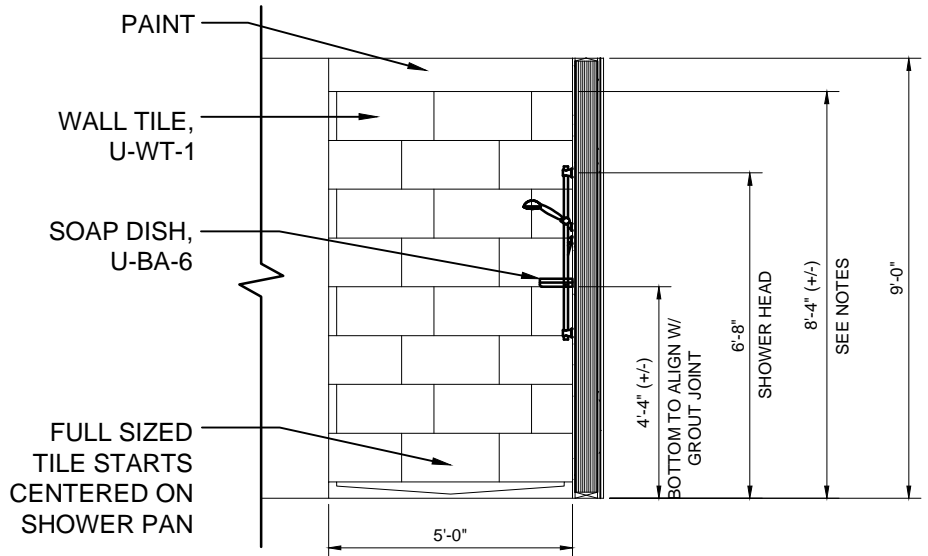

1 TYP. SHOWER TILE PATTERN
SCALE 1/4"=1'-0"

AMARA UNIT WALL TILE PATTERN

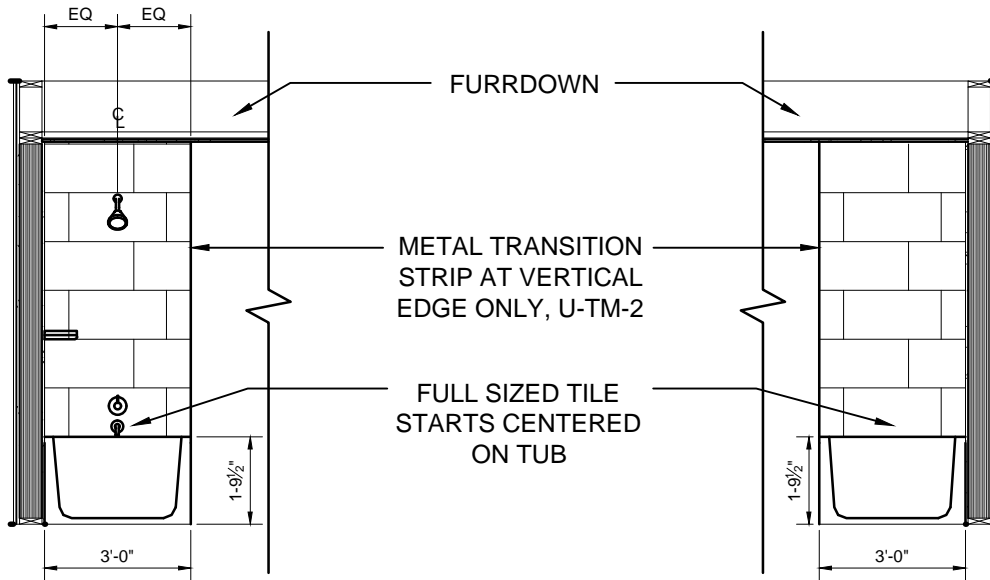

3 TYP. TUB/SHOWER TILE PATTERN
SCALE 1/4"=1'-0"

2 TYP. TUB/SHOWER TILE PATTERN
SCALE 1/4"=1'-0"

TYPICAL WALL TILE NOTES:

1. AT 7'-10" CEILING HEIGHT - WALL TILE IS TO TERMINATE AT CEILING
2. AT 9'-0" CEILING HEIGHT - WALL TILE IS TO TERMINATE WITH A COMPLETE TILE, APPROX. 8'-2" (+/-).

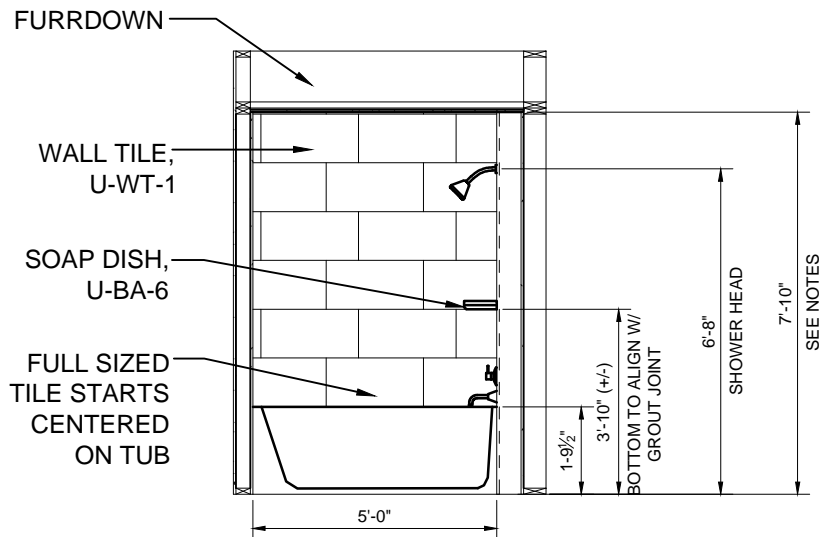

1 TYP. TUB/SHOWER TILE PATTERN
SCALE 1/4"=1'-0"

UNIT
MILLWORK FINISHES

Project Information

Amara
1927 Talavera Ridge
San Antonio, TX 78257



Project Designer Information

Lead Designer:
Janna Paulson, IIDA, LEED AP
janna@ppds-inc.com



PEEL
PAULSON
DESIGN
STUDIO

CABINETRY, PACKAGE 1		U-CAB-1
<p>Location: All Package 1 Unit Kitchen and Bathrooms</p> <p>Description: Manufactured Cabinets Provided by: Master Woodcraft Style: Roma Square Framed, Full Overlay</p> <p>Size: 42" High Upper Cabinets Finish: Nuvolosa Grey</p>		
Notes:		
Contact Information		
<p>Recommended Vendor: Master Woodcraft Address: 232 North Marshall Industrial Avenue Marshall, TX 75670 Website: www.mwccabinetry.com</p> <p>Contact: Kelly Adams Phone: (903) 930-5193 Email: kadams@mwccabinetry.com</p>		
Project Information		
<p>Amara 1927 Talavera Ridge San Antonio, TX 78257</p>		
Project Designer Information		
<p>Lead Designer: Janna Paulson, IIDA, LEED AP janna@ppds-inc.com</p>		

CABINETRY, PACKAGE 2		U-CAB-2
<p>Location: All Package 2 Unit Kitchen and Bathrooms</p> <p>Description: Manufactured Cabinets Provided by: Master Woodcraft Style: Roma Framed, Full Overlay</p> <p>Size: 42" High Upper Cabinets Finish: Espresso</p>		
Notes:		
Contact Information		
<p>Recommended Vendor: Master Woodcraft Address: 232 North Marshall Industrial Avenue Marshall, TX 75670 Website: www.mwccabinetry.com</p> <p>Contact: Kelly Adams Phone: (903) 930-5193 Email: kadams@mwccabinetry.com</p>		
Project Information		
<p>Amara 1927 Talavera Ridge San Antonio, TX 78257</p>		
Project Designer Information		
<p>Lead Designer: Janna Paulson, IIDA, LEED AP janna@ppds-inc.com</p>		

CABINETRY, TOWNHOMES	U-CAB-3
-----------------------------	---------

Location: All Townhome Kitchen and Bathrooms

Description: Manufactured Cabinets
 Provided by: Master Woodcraft
 Style: Roma
 Framed, Full Overlay
 Size: 42" High Upper Cabinets
 Finish: Dover White



Notes:

Contact Information

Recommended Vendor: Master Woodcraft
 Address: 232 North Marshall Industrial Avenue
 Marshall, TX 75670
 Website: www.mwccabinetry.com

Contact: Kelly Adams
 Phone: (903) 930-5193
 Email: kadams@mwccabinetry.com

Project Information

Amara
 1927 Talavera Ridge
 San Antonio, TX 78257

Project Designer Information

Lead Designer:
 Janna Paulson, IIDA, LEED AP
janna@ppds-inc.com



COUNTERTOP		U-S-1
Location: All Unit Kitchens and Bathrooms Description: Quartz Manufacturer: Enchanted Granite Color: Maple White Thickness: 2cm Edge Profile: Square		
Notes: **4" Quartz backsplash at Bathrooms ** No rounded corners or edges		
Contact Information		
Recommended Vendor: Enchanted Granite Address: 2910 Beverly Hill St. Houston, TX 77059 Website: www.enchantedgranite.com Contact: Andrew Baker Phone: 281-998-1700 - Work 281-702-4682 - Cell Email: andrew@enchantedgranite.com		
Project Information		
Amara 1927 Talavera Ridge San Antonio, TX 78257		
Project Designer Information		
Lead Designer: Janna Paulson, IIDA, LEED AP janna@ppds-inc.com		

COUNTERTOP - TOWNHOMES		U-S-2
<p>Location: All Townhome Kitchens and Bathrooms</p> <p>Description: Quartz</p> <p>Manufacturer: Enchanted Granite</p> <p>Color: Duro Gris</p> <p>Thickness: 2cm</p> <p>Edge Profile: Square</p>		
<p>Notes:</p> <p>**4" Quartz backsplash at Bathrooms</p> <p>** No rounded corners or edges</p>		
<p>Contact Information</p> <p>Recommended Vendor: Enchanted Granite</p> <p>Address: 2910 Beverly Hill St. Houston, TX 77059</p> <p>Website: www.enchantedgranite.com</p> <p>Contact: Andrew Baker</p> <p>Phone: 281-998-1700 - Work 281-702-4682 - Cell</p> <p>Email: andrew@enchantedgranite.com</p>		
<p>Project Information</p> <p>Amara 1927 Talavera Ridge San Antonio, TX 78257</p>		
<p>Project Designer Information</p> <p>Lead Designer: Janna Paulson, IIDA, LEED AP janna@ppds-inc.com</p>		
		

UNIT
LIGHTING

Project Information



Amara
1927 Talavera Ridge
San Antonio, TX 78257



Project Designer Information

Lead Designer:
Janna Paulson, IIDA, LEED AP
janna@ppds-inc.com



PEEL
PAULSON
DESIGN
STUDIO

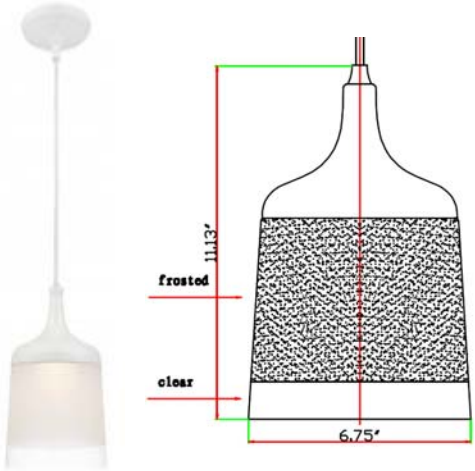

LIGHTING		U-DF-1
<p>Location: Unit Bathrooms See Notes</p> <p>Description: Bath Vanity Wall Mount Manufacturer: Sunpark Electronics Style/Number: FL5539D Size: 35.5"L x 4.8"W x 4.5"H Finish: Satin Nickel Lamp: 39W LED, 3000K Installation: Back plate to be 4" above mirror</p>		
<p>Notes:</p> <p>**At single sink vanities, install 1 light fixture, centered on framed mirror, mounted 4" above mirror.</p> <p>**At double sink vanities, install 2 light fixtures, centered above each sink, mounted 4" above framed mirror.</p> <p>**Unit lighting package to be submitted to Interior Designer for final approval.</p> <p>**Contractor to order sample light fixture to confirm approval of fixture</p>		
<p>Contact Information</p> <p>Recommended Vendor: Sunpark Electronics Address: 16200 S. Figueroa St. Gardena Ca 90248 Website: www.sunparkelectronics.com Contact: Customer Service Phone: 310-324-8880 Email:</p>		
<p>Project Information</p> <p>Amara 1927 Talavera Ridge San Antonio, TX 78257</p>		
<p>Project Designer Information</p> <p>Lead Designer: Janna Paulson, IIDA, LEED AP janna@ppds-inc.com</p>		



LIGHTING		U-DF-2
<p>Location: Kitchen Bar Pendant</p> <p>Description: Custom Pendant</p> <p>Manufacturer: M & M Lighting</p> <p>Style/Number: 65-556-WH (E21)</p> <p>Size: 6.75" Dia x 11.13"H</p> <p>Finish: Brushed Nickel</p> <p>Lamp: (1) 60W</p> <p>Shade: Frosted and Clear Glass</p>	 <p style="text-align: center;">*FINISH TO BE BRUSHED NICKEL*</p>	
<p>Notes:</p> <p>**Refer to MEP plans for quantities and locations.</p> <p>**Unit lighting package to be submitted to Interior Designer for final approval.</p>		
<p>Contact Information</p> <p>Recommended Vendor: M & M Lighting</p> <p>Address: 5620 S. Rice Ave. Houston, TX 77081</p> <p>Website: www.mmlighting.com</p> <p>Contact: Kitty Jennings</p> <p>Phone: (512) 971-5529</p> <p>Email: mmcrj@mmlighting.com</p>		
<p>Project Information</p> <p>Amara 1927 Talavera Ridge San Antonio, TX 78257</p> <hr/> <p>Project Designer Information</p> <p>Lead Designer: Janna Paulson, IIDA, LEED AP janna@ppds-inc.com</p>		



LIGHTING		U-DF-3
<p>Location: Entry, Hallway, Kitchen, Dining Areas, Bathrooms</p> <p>Description: Disk Light</p> <p>Manufacturer: Classic Lighting by J&L</p> <p>Style/Number: 120V 6" LED Disk Light LED-SM6D/WT</p> <p>Dimensions: 7.4"D x 1.6"H for 6" can light</p> <p>Finish: White</p> <p>Lamp: (36) 15w LED chips</p>		
<p>Notes:</p> <p>**Refer to MEP plans for location and quantities.</p> <p>**Lighting Sub Contractor to submit equal alternate options for GC pricing.</p> <p>**Unit lighting package to be submitted to Interior Designer for final approval.</p>		
Contact Information		
<p>Recommended Vendor: J & L Industries Inc.</p> <p>Address: 707 Avenue E. Stafford, TX 77477</p> <p>Website: www.jldistributors.com</p> <p>Contact:</p> <p>Phone: Customer Service</p> <p>Email: 281-403-6733</p>		
Project Information		
<p>Amara 1927 Talavera Ridge San Antonio, TX 78257</p>		
Project Designer Information		
<p>Lead Designer: Janna Paulson, IIDA, LEED AP janna@ppds-inc.com</p>		

LIGHTING		U-DF-4
<p>Location: Unit Exterior Patio Storage</p> <p>Description: Mushroom Ceiling Mount</p> <p>Manufacturer: Lumivert Incorporated</p> <p>Style/Number: 2 Light Opal Mushroom, Energy Saving #ES2801-2131 WT</p> <p>Size: 9-1/2"W x 5"H</p> <p>Finish: White</p> <p>Lamp: (2)13W T2 Spiral CFL E26 Base 3000K</p>		
<p>Notes:</p> <p>**Refer to MEP plans for quantities and locations.</p> <p>**Lighting Sub Contractor to submit equal alternate options for GC pricing.</p> <p>**Unit lighting package to be submitted to Interior Designer for final approval.</p>		
<p>Contact Information</p>		
<p>Recommended Vendor: Lumivert Lighting, Inc.</p> <p>Address: 1515 Mesquite, #C Houston, TX 77093</p> <p>Website: www.lumivertlighting.com</p> <p>Contact: Customer Service</p> <p>Phone: 281-227-8378</p> <p>Email:</p>		
<p>Project Information</p>		
<p>Amara 1927 Talavera Ridge San Antonio, TX 78257</p>		
<p>Project Designer Information</p>		
<p>Lead Designer: Janna Paulson, IIDA, LEED AP janna@ppds-inc.com</p>		



LIGHTING		U-DF-5
<p>Location: Unit Utility and Closets</p> <p>Description: Mushroom Ceiling Mount</p> <p>Manufacturer: Lumivert Incorporated</p> <p>Style/Number: 2 Light Opal Mushroom, Energy Saving #ES2801-2131 BN</p> <p>Size: 9-1/2"W x 5"H</p> <p>Finish: Brushed Nickel</p> <p>Lamp: (2)13W T2 Spiral CFL E26 Base 3000K</p>		
<p>Notes:</p> <p>**Refer to MEP plans for quantities and locations.</p> <p>**Lighting Sub Contractor to submit equal alternate options for GC pricing.</p> <p>**Unit lighting package to be submitted to Interior Designer for final approval.</p>		
<p>Contact Information</p> <p>Recommended Vendor: Lumivert Lighting, Inc.</p> <p>Address: 1515 Mesquite, #C Houston, TX 77093</p> <p>Website: www.lumivertlighting.com</p> <p>Contact: Customer Service</p> <p>Phone: 281-277-8378</p> <p>Email:</p>		
<p>Project Information</p> <p>Amara 1927 Talavera Ridge San Antonio, TX 78257</p>		
<p>Project Designer Information</p> <p>Lead Designer: Janna Paulson, IIDA, LEED AP janna@ppds-inc.com</p>		

LIGHTING		U-DF-6
Location: Unit Living and Bedrooms Description: Ceiling Fan with Light Kit Manufacturer: Sunway Homenhancements Model: SUN505 NK5SV Model Number: 7RQT4 Size: 52"W sweep Finish: Silver Lamp: (2) 13W CFL Glass: White		
Notes: **Refer to MEP plans for quantities and locations. **Unit lighting package to be submitted to Interior Designer for final approval. **Contractor to order sample light fixture to confirm approval of fixture		
Contact Information		
Recommended Vendor: Sunway Homenhancements Address: 1505-A Kelly Blvd. Carrollton, TX 75006 Website: www.homenhancements.com Contact: Customer Service Phone: (972) 416-6090 Email:		
Project Information		
Amara 1927 Talavera Ridge San Antonio, TX 78257		
Project Designer Information		
Lead Designer: Janna Paulson, IIDA, LEED AP janna@ppds-inc.com		

LIGHTING		U-DF-7
Location: Unit Balcony Description: Outdoor Wall Mount, Steel Pan and Aluminum Frame Manufacturer: Divine Lighting Style/Number: Sundance SUNT Size: 6"W x 9"H x 4"D Finish: DB Dark Bronze, MT-Metal Top Lamp: S13GU - (1) 13WGU24 Color Temp: 4100K Lens: WP-White Polycarbonate Ballast: 120 v class P, 60 Hz. Magnetic		
Notes: **Refer to MEP plans for quantities and locations. **Unit lighting package to be submitted to Interior Designer for final approval.		
Contact Information		
Recommended Vendor: Address: Website: Contact: Phone: Email:	Divine Lighting 3704 Hilltop, Ste. 200 Conroe, Texas 77303 www.divinelighting.net Customer Service 936-494-3900	
Project Information		
Amara 1927 Talavera Ridge San Antonio, TX 78257		
Project Designer Information		
Lead Designer: Janna Paulson, IIDA, LEED AP janna@ppds-inc.com		

UNIT
PLUMBING FIXTURES

Project Information

Amara
1927 Talavera Ridge
San Antonio, TX 78257

Project Designer Information

Lead Designer:
Janna Paulson, IIDA, LEED AP
janna@ppds-inc.com



PEEL
PAULSON
DESIGN
STUDIO



[UNIT]

SINK FAUCET		U-PF-1
Location:	Unit Kitchen	
Description:	Single Handle Pull-Down Faucet	
Manufacturer:	Pfister	
Dimensions:	15 25/32"H x 9 1/32" Projection	
Style:	Pasadena	
Model Number:	F-529-7PDS-SS	
Finish:	Stainless Steel	
Mounting:	Single Hole Installation	
Notes:	**Contractor to submit equal alternates for Interior Designer's approval. **ADA Compliant. **Contractor to purchase sample fixture to confirm client approval prior to ordering fuxtures for entire project	
Contact Information		
Recommended Vendor:	Pfister Faucets	
Address:	19701 DaVinci Lake Forest, California 92610	
Contact:	Customer Service	
Phone:	1-800-732-8238	
Website:	www.pfisterfaucets.com	
Project Information		
Amara 1927 Talavera Ridge San Antonio, TX 78257		 PEEL PAULSON DESIGN STUDIO
Project Designer Information		
Lead Designer: Janna Paulson, IIDA, LEED AP janna@ppds-inc.com		

SINK FAUCET		U-PF-2
Location: Unit Bathroom Faucet Description: Single Control Centerset Faucet Manufacturer: Delta Style Name: Trinsic High Arc Swivel Spout Model Number: 559-HA-SS-DST Size: 8 7/8"H Finish: Brushed Nickel Mounting: One Hole Installation Features: ADA Compliant, 1.5gpm		
Notes: **Contractor to submit equal alternates for Interior Designer's approval. **Contractor to ensure proper clearance for faucet lever before ordering. **Contractor to purchase sample fixture to confirm client approval prior to ordering fuxtures for entire project		
Contact Information		
Recommended Vendor: Delta Address: Website: www.deltafaucet.com Contact: Customer Service Phone: Email: www.customerservice@deltafaucet.com		
Project Information		
Amara 1927 Talavera Ridge San Antonio, TX 78257	 PEEL PAULSON DESIGN STUDIO	
Project Designer Information		
Lead Designer: Janna Paulson, IIDA, LEED AP janna@ppds-inc.com		

TUB/SHOWER		U-PF-3
Location: All Unit Bathrooms Description: Single Control tub/shower Trim Manufacturer: CFG by Moen Style Name: Cornerstone Model Number: 4311CBNGR Finish: Brushed Nickel **Note: Use Moen brushed nickel one function 5 7/8" diameter Eco Performance shower head with trim kit. #S6312EPBN GPM: 1.75 gpm		
Notes: **Contractor to provide all necessary components required for installation. **Contractor to submit equal alternates for Interior Designer's approval. **Contractor to purchase sample fixture to confirm client approval prior to ordering fuxtures for entire project		
Contact Information		
Recommended Vendor: CFG by Moen Address: Website: www.cfgonline.com Contact: Customer Service Phone: 888-450-5522 Email:		
Project Information		
Amara 1927 Talavera Ridge San Antonio, TX 78257		
Project Designer Information		
Lead Designer: Janna Paulson, IIDA, LEED AP janna@ppds-inc.com		



SHOWER ONLY		U-PF-4
Location: Unit Bathrooms Description: Single Control Showerhead and Flange Manufacturer: CFG by Moen Style Name: Cornerstone Model Number: 40315CBNGR Finish: Brushed Nickel **Note: Use Moen brushed nickel one function 5 7/8" diameter Eco Performance shower head with trim kit. #S6312EPBN GPM: 1.75 gpm		
Notes: **Contractor to provide all necessary components required for installation. **Contractor to submit equal alternates for Interior Designer's approval. **Contractor to purchase sample fixture to confirm client approval prior to ordering fuxtures for entire project		
Contact Information		
Recommended Vendor: CFG by Moen Address: Website: www.cfgonline.com Contact: Customer Service Phone: 888-450-5522 Email:		
Project Information		
Amara 1927 Talavera Ridge San Antonio, TX 78257		
Project Designer Information		
Lead Designer: Janna Paulson, IIDA, LEED AP janna@ppds-inc.com		

SHOWER - ADA		U-PF-5a
Location: ADA Unit Bathrooms Description: 3 Function Hand Shower with Bracket Manufacturer: ProFlo Style: PF14310CP Finish: Polished Chrome Features: 1.75 gpm		
Notes: **Contractor to submit equal alternates for Interior Designer's approval. **To be installed in ADA units. **Contractor to purchase sample fixture to confirm client approval prior to ordering fuxtures for entire project		
Contact Information		
Recommended Vendor: ProFlo Address: 10500 Metropolitan Dr Austin, TX 78758 Website: www.proflo.com Contact: Customer Service Phone: 512-837-2290 Email:		
Project Information		
Amara 1927 Talavera Ridge San Antonio, TX 78257		
Project Designer Information		
Lead Designer: Janna Paulson, IIDA, LEED AP janna@ppds-inc.com		



[UNIT]

SHOWER SLIDE BAR - ADA		U-PF-5b
Location:	ADA Unit Bathrooms	
Description:	24 Slide Bar with 7/8 Brass Bar	
Manufacturer:	ProFlo	
Style:	PF14BSCP	
Finish:	Polished Chrome	
Notes: **Contractor to submit equal alternates for Interior Designer's approval. **To be installed in ADA units. **Contractor to purchase sample fixture to confirm client approval prior to ordering fuxtures for entire project		
Contact Information		
Recommended Vendor:	ProFlo	
Address:	10500 Metropolitan Dr Austin, TX 78758	
Website:	www.proflo.com	
Contact:	Customer Service	
Phone:	512-837-2290	
Email:		
Project Information		
Amara 1927 Talavera Ridge San Antonio, TX 78257		
Project Designer Information		
Lead Designer: Janna Paulson, IIDA, LEED AP janna@ppds-inc.com		



[UNIT]



SINK		U-PF-6a
Location:	Unit Kitchen	
Manufacturer:	Just Manufacturing	
Description:	Stainless Steel Undermount Single Basin	
Style:	US-1830-A	
Dimensions:	30"L x 18"W	
Bowl Depth:	8"	
Finish:	Stainless Steel	
Gauge:	18	
Drain Punch:	J-35 drain	
Notes: **Contractor to purchase sample fixture to confirm client approval prior to ordering fuxtures for entire project		
Contact Information		
Recommended Vendor:	Just Manufacturing	
Address:	9233 King St Franklin Park, IL 60131	
Website:	www.justmfg.com	
Contact:	Customer Service	
Phone:	847-678-5151	
Email:		
Project Information		
Amara 1927 Talavera Ridge San Antonio, TX 78257		
Project Designer Information		
Lead Designer: Janna Paulson, IIDA, LEED AP janna@ppds-inc.com		

[UNIT]

SINK - ADA		U-PF-6b	
Location:	ADA Unit Kitchen		
Manufacturer:	Just Manufacturing		
Description:	Stainless Steel Undermount Single Basin		
Style:	US-ADA-1830-A		
Dimensions:	30"L x 18"W		
Bowl Depth:	5 1/2"		
Finish:	Stainless Steel		
Gauge:	18		
Notes: **Plumbing contractor to submit equal alternates. **Sink to be installed per ADA requirements to meet knee clearance dimensions. **Contractor to purchase sample fixture to confirm client approval prior to ordering fuxtures for entire project **To be installed per ADA requirements to meet knee clearance dimensions.			
Contact Information			
Recommended Vendor:	Just Manufacturing		
Address:	9233 King St Franklin Park, IL 60131		
Website:	www.justmfg.com		
Contact:	Customer Service		
Phone:	847-678-5151		
Email:			
Project Information			
Amara 1927 Talavera Ridge San Antonio, TX 78257		 PEEL PAULSON DESIGN STUDIO	
Project Designer Information			
Lead Designer: Janna Paulson, IIDA, LEED AP janna@ppds-inc.com			



[UNIT]

SINK		U-PF-7a
Location:	Unit Bathrooms	
Description:	Undermount Sink	
Manufacturer:	American Standard	
Style:	Ovalyn Undercounter Sink	
Style Number:	0496.221	
Overall Dims:	19.25"W x 16.25"L	
Bowl Size:	17"W x 14"L x 5.5" Deep	
Finish:	White 020	
Notes: **Plumbing contractor to submit equal alternates. **Contractor to purchase sample fixture to confirm client approval prior to ordering fuxtures for entire project		
Contact Information		
Recommended Vendor:	American Standard	
Address:		
Website:	www.americanstandard-us.com	
Contact:	Customer Service	
Phone:	1-800-442-1902	
Email:		
Project Information		 PEEL PAULSON DESIGN STUDIO
Amara 1927 Talavera Ridge San Antonio, TX 78257		
Project Designer Information		
Lead Designer: Janna Paulson, IIDA, LEED AP janna@ppds-inc.com		

SINK- ADA		U-PF-7b
Location: ADA Unit Bathrooms Description: Undermount Sink Manufacturer: American Standard Style: Ovalyn Undercounter Sink Style Number: 0495.221 Overall Dims: 17-1/8"W x 14-1/8"L Bowl Size: 15-1/16"W x 12-1/16"L x 5.5" Deep Finish: White 020		
Notes: **Plumbing contractor to submit equal alternates. **Sink to be installed per ADA requirements to meet knee clearance dimensions. **Contractor to purchase sample fixture to confirm client approval prior to ordering fuxtures for entire project		
Contact Information		
Recommended Vendor: American Standard Address: Website: www.americanstandard-us.com Contact: Customer Service Phone: 1-800-442-1902 Email:		
Project Information		
Amara 1927 Talavera Ridge San Antonio, TX 78257	 PEEL PAULSON DESIGN STUDIO	
Project Designer Information		
Lead Designer: Janna Paulson, IIDA, LEED AP janna@ppds-inc.com		

[UNIT]

BATH TUB		U-PF-8
Location:	All Unit Bathtubs	
Description:	Bathtub	
Manufacturer:	Spurlin Industries	
Style:	F 6036 GT L/R	
Finish:	White	
Size:	60"L x 35"W x 21 1/2"H	
Notes: **Contractor to submit equal alternates for Interior Designer's approval. **Contractor to determine left or right drain location based on Architectural drawings. **Contractor to purchase sample fixture to confirm client approval prior to ordering fuxtures for entire project		
Contact Information		
Recommended Vendor:	Ferguson Enterprises, Inc	
Address:	2551 N. Mays Round Rock, TX 78665	
Website:		
Contact:	Scott Supak	
Phone:	512-751-1580	
Email:	scott.supak@ferguson.com	
Project Information		
Amara 1927 Talavera Ridge San Antonio, TX 78257		 PEEL PAULSON DESIGN STUDIO
Project Designer Information		
Lead Designer: Janna Paulson, IIDA, LEED AP janna@ppds-inc.com		

TOILET		U-PF-9a
Location: Unit Bathrooms Description: Elongated Toilet Manufacturer: Gerber Style Name: Maxwell HET Elongated Toilet Style Number: 21-912 GPF: 1.28 Finish: White		
Notes: **Contractor to submit equal alternates for Interior Designer's approval. **Contractor to purchase sample fixture to confirm client approval prior to ordering fixtures for entire project		
Contact Information		
Recommended Vendor: Gerber Address: Website: www.gerberonline.com Contact: Customer Service Phone: 866-538-5536 Email:		
Project Information		
Amara 1927 Talavera Ridge San Antonio, TX 78257		
Project Designer Information		
Lead Designer: Janna Paulson, IIDA, LEED AP janna@ppds-inc.com		

[UNIT]

TOILET - ADA		U-PF-9b
Location: ADA Unit Bathrooms		
Description: Elongated Toilet		
Manufacturer: Gerber		
Style Name: Maxwell HET Elongated Toilet		
Style: 21-918		
GPF: 1.28		
Finish: White		
Notes: **Contractor to submit equal alternates for Interior Designer's approval. **To be installed in ADA units. **Contractor to purchase sample fixture to confirm client approval prior to ordering fuxtures for entire project		
Contact Information		
Recommended Vendor: Gerber		
Address:		
Website: www.gerberonline.com		
Contact: Customer Service		
Phone: 866-538-5536		
Email:		
Project Information		 PEEL PAULSON DESIGN STUDIO
Amara 1927 Talavera Ridge San Antonio, TX 78257		
Project Designer Information		
Lead Designer: Janna Paulson, IIDA, LEED AP janna@ppds-inc.com		

[UNIT]

SHOWER PAN

U-PF-10

Location: Unit Bathrooms
Description: Molded Fiberglass Shower Receptor
Manufacturer: TBD
Style: TBD
Finish: White
Size: 36"W x 60"L

TBD

Notes:

**Contractor to submit equal alternates for Interior Designer's approval.
**Contractor to purchase sample fixture to confirm client approval prior to ordering fixtures for entire project

Contact Information

Recommended Vendor: TBD
Address:

Contact:
Phone:
Website:

Project Information

Amara
1927 Talavera Ridge
San Antonio, TX 78257

Project Designer Information

Lead Designer:
Janna Paulson, IIDA, LEED AP
janna@ppds-inc.com



PEEL
PAULSON
DESIGN
STUDIO

[UNIT]

UNIT
BATH ACCESSORIES

Project Information

Amara
1927 Talavera Ridge
San Antonio, TX 78257



Project Designer Information

Lead Designer:
Janna Paulson, IIDA, LEED AP
janna@ppds-inc.com





[UNIT]



BATH ACCESSORY		U-BA-1
Location:	Unit Bathrooms	
Description:	24" Towel Bar	
Manufacturer:	Taymor	
Style:	Dixon	
Product:	24" Towel Bar	
Model Number:	04-30624SN	
Size:	24" x 13/16" x 1/4"	
Finish:	Satin Nickel	
Notes: **Contractor to submit equal alternates for Interior Designer's approval.		
Contact Information		
Recommended Vendor:	Taymor	
Address:	1655 Derwent Way Annacis Island, Delta, BC V3M6K8	
Contact:	Customer Service	
Phone:	604-540-9525	
Website:	www.taymor.ca	
Project Information		
Amara 1927 Talavera Ridge San Antonio, TX 78257		
Project Designer Information		
Lead Designer: Janna Paulson, IIDA, LEED AP janna@ppds-inc.com		

BATH ACCESSORY		U-BA-2
Location: Unit Bathrooms Description: 18" Towel Bar Manufacturer: Taymor Style: Dixon Product: 18" Towel Bar Model Number: 04-30618SN Size: 18" x 13/16" x 1/4" Finish: Satin Nickel		
Notes: **Contractor to submit equal alternates for Interior Designer's approval.		
Contact Information		
Recommended Vendor: Taymor Address: 1655 Derwent Way Annacis Island, Delta, BC V3M6K8 Contact: Customer Service Phone: 604-540-9525 Website: www.taymor.ca		
Project Information		
Amara 1927 Talavera Ridge San Antonio, TX 78257		
Project Designer Information		
Lead Designer: Janna Paulson, IIDA, LEED AP janna@ppds-inc.com		

[UNIT]

BATH ACCESSORY		U-BA-3
Location:	Unit Bathrooms	 <p>**Satin Nickel Finish**</p>
Description:	Tissue Holder	
Manufacturer:	Taymor	
Style:	Dixon	
Product:	Standard Paper Holder	
Model Number:	04-30608SN	
Finish:	Satin Nickel	
Notes: **Contractor to submit equal alternates for Interior Designer's approval.		
Contact Information		
Recommended Vendor:	Taymor	
Address:	1655 Derwent Way Annacis Island, Delta, BC V3M6K8	
Contact:	Customer Service	
Phone:	604-540-9525	
Website:	www.taymor.ca	
Project Information		
Amara 1927 Talavera Ridge San Antonio, TX 78257		
Project Designer Information		
Lead Designer: Janna Paulson, IIDA, LEED AP janna@ppds-inc.com		

[UNIT]

BATH ACCESSORY		U-BA-4
Location: Unit Bathrooms		 <p>**Satin Nickel Finish**</p>
Description: Towel Ring Manufacturer: Taymor Style: Dixon Product: Towel Ring Model Number: 04-30604SN Finish: Satin Nickel		
Notes: **Contractor to submit equal alternates for Interior Designer's approval.		
Contact Information		
Recommended Vendor: Taymor Address: 1655 Derwent Way Annacis Island, Delta, BC V3M6K8		
Contact: Customer Service Phone: 604-540-9525 Website: www.taymor.ca		
Project Information		
Amara 1927 Talavera Ridge San Antonio, TX 78257		
Project Designer Information		
Lead Designer: Janna Paulson, IIDA, LEED AP janna@ppds-inc.com		

[UNIT]

BATH ACCESSORY		U-BA-5
Location:	Unit Bathrooms	 <p>The image shows a curved shower rod and two views of its end cap. The end cap dimensions are: 1-13/32" (width), 1-7/16" (depth), 3" (height), 2" (height), and 2-1/2" (width).</p>
Description:	Curved Shower Rod	
Manufacturer:	Pamex Inc.	
Style:	Crescent Curved 5ft Rod	
Model Number:	BSR-552	
Size:	5' L x 1"D	
Finish:	Satin Nickel	
Notes:		
Contact Information		
Recommended Vendor:	Pamex Inc.	
Address:		
Contact:	Customer Service	
Phone:	800-621-6869	
Website:	www.pamexinc.com	
Project Information		
Amara 1927 Talavera Ridge San Antonio, TX 78257		 <p>PPDS PEEL PAULSON DESIGN STUDIO</p>
Project Designer Information		
Lead Designer: Janna Paulson, IIDA, LEED AP janna@ppds-inc.com		

[UNIT]

BATH ACCESSORY		U-BA-6
Location:	Unit Bathrooms	
Manufacturer:	Interceramics	
Description:	Medium Corner Caddy	
Style:	White Ceramic Bathroom Shelf	
Finish:	Ceramic	
Size:	8-1/4" x 8-1/4"	
Color:	White	
Notes: **Contractor to submit equal alternates for Interior Designer's approval. **Refer to typical tub/shower wall tile pattern elevation for mounting height. Drawing located in wall tile section of specification book.		
Contact Information		
Recommended Vendor:	Interceramic USA	
Address:	9701 Metric Blvd., #100 Austin, TX 78758	
Website:	www.interceramicusa.com	
Contact:	Esther Rollins	
Phone:	512-497-9459	
Email:	erollins@interceramic.com	
Project Information		
Amara 1927 Talavera Ridge San Antonio, TX 78257		
Project Designer Information		
Lead Designer: Janna Paulson, IIDA, LEED AP janna@ppds-inc.com		

[UNIT]

UNIT
DOOR STYLE & HARDWARE

Project Information



Amara
1927 Talavera Ridge
San Antonio, TX 78257



Project Designer Information



Lead Designer:
Janna Paulson, IIDA, LEED AP
janna@ppds-inc.com



PEEL
PAULSON
DESIGN
STUDIO

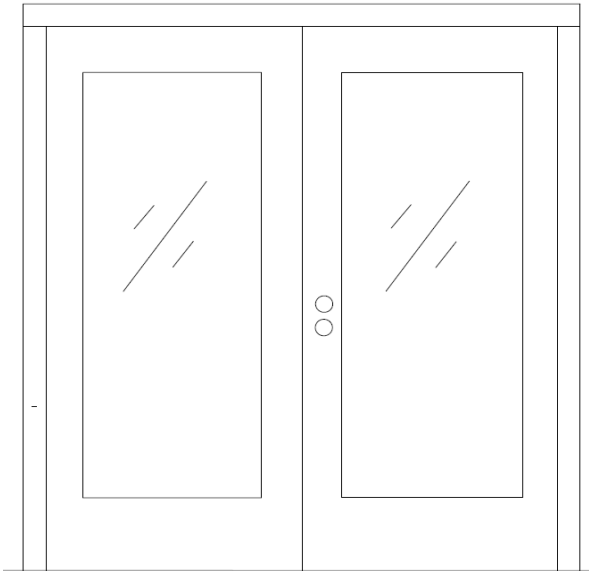

DOOR		U-D-1
<p>Location: All Unit Interior Doors</p> <p>Description: Interior 3 Panel Door</p> <p>Manufacturer: Provided by Sub Contractor</p> <p>Series: 3 Panel</p> <p>Height: 6'-8"</p> <p>Type: Moulded</p> <p>Finish: Smooth</p> <p>Paint Color: U-PT-2 Sherwin Williams SW 7070 Site White</p>		
<p>Notes:</p> <p>**Confirm door height and thickness with Architectural Door Schedule.</p> <p>**Confirm all Fire Rating requirements with Architect.</p>		
<p>Contact Information</p> <p>Recommended Vendor: Sub Contractor</p> <p>Address:</p> <p>Website:</p> <p>Contact:</p> <p>Phone:</p> <p>Email:</p>		
<p>Project Information</p> <p>Amara 1927 Talavera Ridge San Antonio, TX 78257</p>		
<p>Project Designer Information</p> <p>Lead Designer: Janna Paulson, IIDA, LEED AP janna@ppds-inc.com</p>		

DOOR		U-D-2
<p>Location: All Unit Entry Doors</p> <p>Description: Exterior 2 Panel Door</p> <p>Manufacturer: Provided by Sub Contractor</p> <p>Style: 2 Panel, No Glass</p> <p>Height: 8'-0"</p> <p>Type: Metal</p> <p>Finish: Smooth</p> <p>Paint Color: To Be Determined By Owner</p>		
<p>Notes:</p> <p>**Confirm door height and thickness with Architectural Door Schedule.</p> <p>**Confirm all Fire Rating requirements with Architect.</p>		
<p>Contact Information</p> <p>Recommended Vendor: Sub Contractor</p> <p>Address:</p> <p>Website:</p> <p>Contact:</p> <p>Phone:</p> <p>Email:</p>		
<p>Project Information</p> <p>Amara 1927 Talavera Ridge San Antonio, TX 78257</p>		
<p>Project Designer Information</p> <p>Lead Designer: Janna Paulson, IIDA, LEED AP janna@ppds-inc.com</p>		

DOOR		U-D-3
<p>Location: All Unit Patio Doors</p> <p>Description: Exterior Single Lite</p> <p>Manufacturer: Provided by Sub Contractor</p> <p>Style: Full Lite Metal Door</p> <p>Height: 8'-0"</p> <p>Type: Metal</p> <p>Finish: Smooth</p> <p>Paint Color: To Be Determined By Owner</p>		
<p>Notes:</p> <p>**Confirm door height and thickness with Architectural Door Schedule.</p> <p>**Confirm all Fire Rating requirements with Architect.</p>		
<p>Contact Information</p> <p>Recommended Vendor: Sub Contractor</p> <p>Address:</p> <p>Contact:</p> <p>Phone:</p> <p>Website:</p>		
<p>Project Information</p> <p>Amara 1927 Talavera Ridge San Antonio, TX 78257</p>		
<p>Project Designer Information</p> <p>Lead Designer: Janna Paulson, IIDA, LEED AP janna@ppds-inc.com</p>		

HARDWARE		U-H-1
<p>Location: Unit Privacy Doors: Bedrooms & Bathrooms</p> <p>Description: Privacy Door Lever</p> <p>Manufacturer: Better Home Products</p> <p>Style: Soma Lever, Privacy</p> <p>Finish: Satin Nickel</p>		
<p>Notes:</p> <p>**Contractor to verify all locking information with Owner.</p>		
<p>Contact Information</p> <p>Recommended Vendor: Better Home Products</p> <p>Address:</p> <p>Website: www.betterhomeproducts.com</p> <p>Contact: Customer Service</p> <p>Phone: 650-827-9270</p> <p>Email:</p>		
<p>Project Information</p> <p>Amara 1927 Talavera Ridge San Antonio, TX 78257</p>		
<p>Project Designer Information</p> <p>Lead Designer: Janna Paulson, IIDA, LEED AP janna@ppds-inc.com</p>		
		

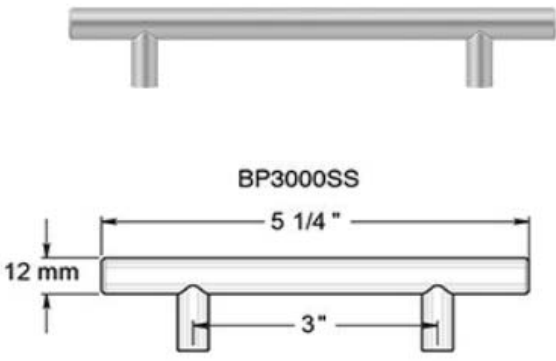
HARDWARE		U-H-2
<p>Location: Unit Passage Doors: Entry, Closets & Utility</p> <p>Description: Passage Door Lever</p> <p>Manufacturer: Better Home Products</p> <p>Style: Soma Lever, Passage Door</p> <p>Finish: Satin Nickel</p>		
<p>Notes:</p> <p>**Entry Door to receive Client approved deadbolt provided by Contractor.</p>		
<p>Contact Information</p> <p>Recommended Vendor: Better Home Products</p> <p>Address:</p> <p>Website: www.betterhomeproducts.com</p> <p>Contact: Customer Service</p> <p>Phone: 650-827-9270</p> <p>Email:</p>		
<p>Project Information</p> <p>Amara 1927 Talavera Ridge San Antonio, TX 78257</p>		
<p>Project Designer Information</p> <p>Lead Designer: Janna Paulson, IIDA, LEED AP janna@ppds-inc.com</p>		

HARDWARE		U-H-3
<p>Location: Unit Kitchen & Bathrooms</p> <p>Description: Cabinet Pull</p> <p>Manufacturer: Deltana</p> <p>Style: Bar Pull</p> <p>Model Number: BP3000SS</p> <p>Finish: Stainless Steel</p> <p>Dimensions: 5.25" Overall Length 3" C to C</p>		
<p>Notes:</p> <p>**Contractor may provide "or equal" for Interior Designer's approval.</p>		
<p>Contact Information</p> <p>Recommended Vendor: Deltana</p> <p>Address:</p> <p>Website: www.deltana.net</p> <p>Contact: Customer Service</p> <p>Phone: 1-800-665-2226</p> <p>Email:</p>		
<p>Project Information</p> <p>Amara 1927 Talavera Ridge San Antonio, TX 78257</p> <hr/> <p>Project Designer Information</p> <p>Lead Designer: Janna Paulson, IIDA, LEED AP janna@ppds-inc.com</p>		

UNIT
MISCELLANEOUS

Project Information

Amara
1927 Talavera Ridge
San Antonio, TX 78257



Project Designer Information

Lead Designer:
Janna Paulson, IIDA, LEED AP
janna@ppds-inc.com





PEEL
PAULSON
DESIGN
STUDIO



[UNIT]

MISCELLANEOUS		U-M-1	
Location:	All Units throughout		
Description:	Switchplates and Outlet Covers		
Manufacturer:	Cooper Wiring Devices		
Style:	2132W		
Finish:	White		
Notes:			
Contact Information			
Recommended Vendor:	Cooper Wiring Devices		
Address:			
Contact:	Customer Service		
Phone:	866-853-4293		
Website:	www.cooperindustries.com		
Project Information			
Amara 1927 Talavera Ridge San Antonio, TX 78257			
Project Designer Information			
Lead Designer: Janna Paulson, IIDA, LEED AP janna@ppds-inc.com			

[UNIT]

MISCELLANEOUS		U-M-2
Location: All Units throughout		
Description: Light Switch		
Manufacturer: Cooper Wiring Devices		
Style: Rocker Switch		
Finish: White		
Notes:		
Contact Information		
Recommended Vendor: Cooper Wiring Devices		
Address:		
Contact: Customer Service		
Phone: 866-853-4293		
Website: www.cooperindustries.com		
Project Information		
Amara 1927 Talavera Ridge San Antonio, TX 78257		
Project Designer Information		
Lead Designer: Janna Paulson, IIDA, LEED AP janna@ppds-inc.com		

[UNIT]

MISCELLANEOUS		U-M-3
Location:	All Units throughout	
Description:	Wall Texture	
Manufacturer:	Contractor	
Style:	Medium Orange Peel	
Notes:		
Contact Information		
Recommended Vendor:	General Contractor	
Address:		
Contact:		
Phone:		
Email:		
Project Information		
Amara 1927 Talavera Ridge San Antonio, TX 78257		
Project Designer Information		
Lead Designer: Janna Paulson, IIDA, LEED AP janna@ppds-inc.com		

MISCELLANEOUS		U-M-4
Location: Window Blinds Throughout Description: Faux wood collection Manufacturer: Graber Style: 2" Faux Wood Traditions #2539 Finish: Artic White		
Notes: **Contractor to submit "or equal" options to Interior Designer for approval.		
Contact Information		
Recommended Vendor: Graber Address: Contact: Customer Service Phone: 877-792-0002 Website: www.graberblinds.com		
Project Information		
Amara 1927 Talavera Ridge San Antonio, TX 78257		
Project Designer Information		
Lead Designer: Janna Paulson, IIDA, LEED AP janna@ppds-inc.com		

MISCELLANEOUS		U-M-5
Location: Unit Bathrooms Throughout Description: Framed Mirrors Manufacturer: Framerica Style: BW241-061 Finish: Espresso Walnut Size: 2"W x 3/4"H x 1/2"Rabbet		
Notes: **At ADA Units, wood frame to sit directly on vanity backsplash per ADA requirements so that the reflective surface of mirror is at 40" AFF MAX. **At Standard Units, wood frame to be mounted 1.5" above vanity backsplash.		
Contact Information		
Recommended Vendor: Framerica Address: 2 Todd Court Yaphank, NY 11980 Contact: Customer Service Phone: 800-372-6422 Website: www.framerica.com		
Project Information		
Amara 1927 Talavera Ridge San Antonio, TX 78257		
Project Designer Information		
Lead Designer: Janna Paulson, IIDA, LEED AP janna@ppds-inc.com		